

**O  
P  
E  
R  
A  
T  
I  
O  
N  
S  
  
M  
A  
N  
U  
A  
L**



**Leaders in Environmental Compliance Products**

# **TFSO**

## Tank-Full Shut-Off System

PO Box 3726  
6095 Jackson Road  
Ann Arbor, Michigan 48106-3726

1565 Alvarado Street  
San Leandro, California 94577-2640

(800) 624-2026 — North America Only  
(734) 995-2547 — Tele.  
(734) 995-1170 — Fax  
info@qedenv.com — E-mail  
www.qedenv.com

(800) 537-1767 — North America Only  
(510) 346-0400 — Tele.  
(510) 346-0414 — Fax

Copyright QED Environmental Systems, **November 2008**

Document No. **600004-06**

The equipment in this manual is protected under U.S. and foreign patents issued and pending:

U.S. Patents:

Selective Oil Skimmer (SOS)	4,497,370
Specific Gravity Skimmer (SPG)	4,663,037
AutoPump (AP)	5,004,405
Specific Gravity Skimmer (SPG) Product Sensing	5,474,685
Vacuum/Pressure Hydrocarbon Recovery System	4,761,225
SPG PSR technology	5,474,685
AP-2	5,641,272
Genie System	5,704,772

Canada Patent:

Specific Gravity Skimmer (SPG)	1,239,868
--------------------------------	-----------

"AP" is a Registered Trademark of "QED Environmental Systems"

"AutoPump" is a Registered Trademark of "QED Environmental Systems"

"SOS" is a Registered Trademark of "QED Environmental Systems"

"Genie" is a Registered Trademark of "QED Environmental Systems"

"SPG" is a Registered Trademark of "QED Environmental Systems"

"AutoSkimmer" is a Registered Trademark of "QED Environmental Systems"

The QED Environmental Systems logo is a Registered Trademark of "QED Environmental Systems"

QED Environmental Systems is a Registered Trademark of "QED Environmental Systems"



# Table of Contents

<b>Introduction</b>	<b>1</b>
Safety .....	1
Service .....	2
<b>Chapter 1: Safety</b>	<b>3</b>
A Partial List of Safety Procedures .....	3
Fire and Explosion Protection .....	4
Personal Protection .....	4
Spill Protection .....	5
<b>Chapter 2: Overview</b>	<b>6</b>
Equipment Design .....	6
Equipment Overview .....	6
General Specifications .....	7
Method of Operation .....	7
Major TFSO System Features .....	8
Options and Accessories .....	8
<b>Chapter 3: Unpacking</b>	<b>9</b>
Unpacking .....	9
Typical Equipment Packages .....	9

## **Chapter 4: Installation and Operation** \_\_\_\_\_ **11**

Cautions .....	11
I. Installation .....	12
Wall Mount TFSO System .....	12
Tank Mount TFSO System .....	17
II. Operation .....	20
Start Up Check List .....	20
Start Up Procedure .....	20
Observation of System Operation .....	21
Tank-Full Shut-Off Trip Condition .....	21
Cold Weather Condition .....	23
High Humidity Condition .....	24

## **Chapter 5: Maintenance** \_\_\_\_\_ **25**

General Maintenance .....	25
Maintenance Table .....	26
Two Stage Filter/Regulator .....	26
Oil Indicating Filter .....	27
Tank-Full Shut-Off Test .....	28

## **Chapter 5: Troubleshooting and Repair** \_\_\_\_\_ **30**

Troubleshooting .....	30
Returning Equipment for Service .....	39
Equipment Cleaning Requirements .....	40

## **Appendix A: Equipment Specifications** \_\_\_\_\_ **41**

Equipment List .....	41
Components and Functions .....	43
Hoses and Fittings .....	53
Options and Accessories .....	54

**Terms, Conditions, and Warranty** \_\_\_\_\_ **56****Figures:**

Figure 1 - Locking Quick-Connect Instructions .....	13
Figure 2 - Wall-Mount TFSO Assembly with Button Sensor TEE .....	14
Figure 3 - Wall-Mount TFSO with AutoPump Downwell System.....	16
Figure 4 - Tank-Mount TFSO with AutoGenie and SOS-4 Downwell System.....	18
Figure 5 - Multi-Well Tank-Mount TFSO with AutoGenie and SOS-4 Downwell System .....	19
Figure 6 - Amplifier .....	34
Figure 7 - Wall-Mount Control Box Exterior .....	46
Figure 8 - Wall-Mount Control Box Interior .....	47
Figure 9 - Tank Mount Control Box Exterior .....	48
Figure 10 - Tank Mount Control Box Interior .....	49
Figure 11 - High Flow Wall Mount Control Box and Filter/Regulator .....	50
Figure 12 - High Flow Control Box Interior .....	51
Figure 13 - Tank-Full Shut-Off Tank Unit (Wall Mount Systems).....	52
Figure 14 - Tank Adapter for Product Only Systems .....	54

# Introduction

Welcome to QED Environmental Systems' Tank-Full Shut-Off (TFSO) System manual.

To ensure the best operator safety and system performance, please read this manual before using the system.

This manual reflects our many years of experience and includes comments and suggestions from our sales and service personnel and most importantly from our customers. The chapters, their contents and sequence were designed with you, the user and installer, in mind. We wrote this manual so it can be easily understood by users who may not be familiar with systems of this type or are using a *QED* system for the first time.

## Safety

---

Safety has been a cornerstone of our design which has been proven over fifteen years of building and shipping systems throughout the world. Our high level of performance is achieved by using quality components, building in redundancies or backup systems, and not compromising our commitment to quality manufacturing. The net result is the highest quality and safest pneumatic pump recovery system on the market. We feel so strongly about safety, based on years of working with the hydrocarbon industry, that it is the first chapter in all of our manuals.

## How to Contact *QED*

If for any reason you are unable to find what you need in this manual please feel free to contact the *QED* Service Department at any time.

**Service Department**  
**QED Environmental Systems**  
**[www.qedenv.com](http://www.qedenv.com)**

**San Leandro Service Center**  
1565 Alvarado Street  
San Leandro, California 94577-2640

((800) 537-1767 — North America Only  
(510) 346-0400 — Tele.  
(510) 346-0414 — Fax

**Ann Arbor Service Center**  
PO Box 3726  
6095 Jackson Road  
Ann Arbor, Michigan 48106-3726

(800) 624-2026 — North America Only  
(734) 995-2547 — Tele.  
(734) 995-1170 — Fax  
[info@qedenv.com](mailto:info@qedenv.com) — E-mail

***QED* can be reached 24 hours a day**

We welcome your comments and encourage your feedback regarding anything in this manual and the equipment you have on site.

Thank you again for specifying *QED* remediation equipment.

# Chapter 1: Safety

Safety has been a prime consideration when designing the TFSO System. Safety guidelines are provided in this manual, and the TFSO System safety features are listed below. Please do not attempt to circumvent the safety features of this system.

We have also listed some possible hazards involved when applying this system to site remediation. Nothing will protect you as much as understanding the system, the site at which it is being used, and the careful handling of all the equipment and fluids. If you have any questions, please contact the *QED* Service Department for guidance.

As you read through this manual, you will encounter three kinds of warnings. The following examples indicate how they appear and their purpose.

<b>Note:</b>	Information of interest.
<b>Caution:</b>	Ways to avoid damaging equipment.
<b>WARNING:</b>	Personal safety.

## A Partial List of Safety Procedures

---

**WARNING:**

The air compressor and any other electrical equipment used with this pneumatic system must be positioned outside of any area considered hazardous because of possible combustible materials.

---

These safety procedures should be followed at all times when operating *QED* equipment on or off site, and should be considered as warnings.

- Wear safety goggles when working with the TFSO System to protect eyes from any splashing or pressure release.



- Wear chemically resistant rubber gloves, boots and coveralls when handling the TFSO System and fluid discharge hose to avoid skin contact with the fluid being recovered.
- Point all hoses away from personnel and equipment when connecting or disconnecting.
- Refer to Appendix A: Equipment & Specifications for a list of parts and hoses supplied with the TFSO System.

The TFSO System minimizes the potential for accidents with the following safeguards:

### **Fire and Explosion Protection**

---

All *QED* underground fluid extraction systems are pneumatic. This offers many inherent fire and explosion protection features:

- No electricity is used, only pneumatics, resulting in reduced risk of fires or explosions.
- Standard systems use brass fittings to eliminate sparking hazard.

### **Personal Protection**

---

On-site, service and maintenance personnel can safely use *QED* equipment. Safety-in-use is the primary design feature in all systems. Following are some examples:

- All standard high pressure air hoses have automatic shut off quick-connects on the supply side which prevents injury due to hose whip or air blown particles. Tubing does not usually have quick-connect fittings, but is pushed over barbs or pushed into compression fittings.
- Metal regulators and filter bowls are rated at 150 psi. The metal air filter bowl provides greater pressure and chemical resistance than plastic bowls and it is less prone to damage if dropped.
- Product hoses have double shut-off valves to prevent spills and personnel injury.

---

## Spill Protection

---

On-site spills cannot always be prevented. *QED* equipment is designed to take into consideration such unpredictable occurrences that may happen despite strict adherence to standardized safety practices.

- The standard air and fluid hoses are rated at over 800 psi burst pressure to prevent accidental hose breakage.
- Tubing is rated lower than hoses. Tubing burst pressure is dependent upon its construction. The sensor tubing in the TFSSO System carries only 1.5 psi and is rated at 60 psi at 80° F.
- Two independent product tank-full sensors inform the TFSSO System when the recovery tank is full, halting operation of the pumping system, and preventing overflow of the recovery tank. The system shuts down if connections or hoses are vandalized. In addition, should all sensors fail, a fail safe overflow option returns the product to the well.

## Chapter 2: Overview

### Equipment Design

---

QED equipment design reflects simplicity.

Most QED systems have no-mix quick-connect fittings and color coded hoses, which means problems caused by improper connections are impossible—hoses can only be attached one way. All QED Skimmers, for example, can be disassembled in the field, checked for offending problems, and reassembled, all without any tools or complicated procedures. Less expensive tubing and barb fittings are also available.

Furthermore, all equipment is field serviceable, and some products are also field upgradeable as site needs change. These simple design approaches mean less downtime during service intervals, time spent by maintenance personnel, and the need for second or third party service experts to perform basic tasks.

### Equipment Overview

---

There are three TFSO System types: Tank-Mount, Wall-Mount and High Flow Tank Mount. Their design have two sensors with their end points in the TFSO tank unit mounted in a 2-inch NPT fitting in the recovery tank to be monitored. A small amount of air is bled into the tubes connected to each sensor. A small change in the pressure in either tube will cause the system to activate.

This system is very versatile and available in a wide range of lengths, valve arrangements, and materials of construction to meet particular site specifications.

Equipment may vary by application and site specifications.  
(See Appendix A: Equipment Specifications)

## General Specifications

---

Temperature Range: 33° F to 110° F\*.

Pressure Range: 60 to 120 psi

Air Flow:

Inlet Air PSI	Regulator Setting PSI	Outlet PSI	Wall Mount TFSO Air Flow	Tank Mount TFSO Air Flow	High Flow TFSO Air Flow
			SCFM	SCFM	SCFM
120	100	90	10	6.5	36
120	100	85	13.5	9	47
100	80	70	9.5	5.5	31
100	80	65	12.5	8	40

\* Air expansion causes temperature drops, so compressed air above 32° F may drop below freezing when it is decompressed.

## Method of Operation

---

The TFSO System will cease passing compressed air to downstream systems when the recovery tank is full. Either a float will rise—releasing a small amount of pressure behind a button valve—or through an increase in pressure, a bubbler tube will signal if there is a rise in fluid.

The hoses are color coded and all the fittings are different so only the proper connections can be made.

The TFSO control includes a two stage filter/regulator. Another filter is provided inside the control box for added reliability; this filter also has a visual indicator.

---

Note:

An automatic drain on the compressor is highly recommended since it dramatically decreases air filter maintenance. QED can supply an automatic drain.

---

## Major TFSO System Features

---

- The hoses and tubing are color coded and all the fittings are different so only the proper connections can be made.
- System operation is simple, straightforward and automatic. Built-in safety features result in operator-free operations even on nights and weekends.
- The TFSO system can be upgraded to monitor additional recovery tanks.
- The TFSO System is small and lightweight and can be easily moved from site to site.
- The Wall-Mount TFSO has a three-way valve that allows the operator to shut down the system, exhausting all down stream air without disconnecting hoses or “tripping” the system.
- Rugged construction ensures long system life, even under harsh conditions.
- The entire system is pneumatically powered with no electrical components, thus avoiding sparks in control power and sensing devices.

---

### Caution:

Alteration of the System: Do not change or modify the system without the express written approval of QED.

---

## Options and Accessories

---

The following options and accessories are available from QED. Contact your QED Representative regarding the following:

- Tank adapter (See Appendix A)
- Downstream equipment air supply hose (See Appendix A)
- Single stage filter/regulator (FR-35)
- Single sensor TFSO tank units for multiple tanks
- Remote monitoring
- TFSO tank units of various lengths to accommodate different size tanks
- Multi-well systems (See Figure 5)
- Locking features on quick-connects to prevent accidental parting of connections.

# Chapter 3: Unpacking

## Unpacking

---

During the unpacking procedure, check for the following:

- All parts on the packing list have been included in the box
- All fitting openings are unobstructed
- The equipment has not been damaged in shipment; e.g. cracked float, pinched or cut hose

## Typical Equipment Packages

---

The equipment list will vary depending on site specifications, but the following lists are typical configurations:

### Wall-Mount TFSO System

1. TFSO control box
2. TFSO tank unit
3. Tank Adapter
4. Hoses/Tubing:
  - Dual TFSO sensor\*
  - Fume return/overflow
  - System air supply

\*This is composed of two tubings. For lengths up to 75 feet, each tube is 1/8-inch I.D. For lengths between 75 feet and 300 feet, the I.D. is 1/4-inch. For lengths from 300 feet to 1,000 feet, the I.D. is 3/8-inch.

## Wall-Mount HIGH FLOW TFSO System

1. TFSO control box
2. Special High Flow Valve and Wall Mount Filter/Regulator Assembly
3. TFSO tank unit
4. Hoses/Tubing:
  - Dual TFSO sensor\*
  - Fume return/overflow
  - System air supply

\*This is composed of two tubings. For lengths up to 75 feet, each tube is 1/8-inch I.D. For lengths between 75 feet and 300 feet, the I.D. is 1/4-inch. For lengths from 300 feet to 1,000 feet, the I.D. is 3/8-inch.

## Tank-Mount TFSO System

1. TFSO-TM control box
2. Tank Adapter
3. Hoses:
  - Fume return/overflow
  - System air supply

## Options and Accessories

Contact your *QED* Representative regarding the following:

- Tank adapter (See Appendix A)
- Downstream equipment air supply hose (See Appendix A)
- Single stage filter/regulator (FR-35)
- Single sensor TFSO tank units for multiple tanks
- Remote monitoring
- TFSO tank units of various lengths to accommodate different size tanks
- Multi-well systems (See Figure 5)
- Locking features on quick-connects to prevent accidental parting of connections.

## Chapter 4: Installation and Operation

### Cautions

---

---

**WARNING:**

Do not use PVC pipe for compressed air conduit. It is not considered a safe use of material.

---

- Cover the hose ends with tape if they are being pulled through trenches. Be sure the ends of the hoses that connect to the air compressor and fluid discharge have the correct fitting leading out of the well. If you are unsure, look at the respective fittings on the pump.
- Blow out all compressed air conduits (trunk lines, sensor hoses, air supply hoses etc.) and fluid lines for at least 10 seconds before connecting them to the system.
- When running hoses in conduit, include a rope to pull additional hoses in case they are needed at a later date.
- If solid metal piping is used for compressed air conduit, it is advised that an air filter or a “Y” strainer with a fine mesh screen (a 60 mesh or greater) be placed at the downstream end of the piping. Metal flakes, rust, galvanizing material, dirt, etc. can be dislodged from such metal piping and travel to the pump or controls.



## I. Installation

---

### Quick-Connects

If your TFSO System has locking quick-connects, follow the instructions on Figure 1 (following page). Most TFSO Systems do not have locking quick-connects. The sleeve on the quick-connect is pulled back to connect and disconnect.

### Wall-Mount TFSO System

- STEP 1 -** Mount the TFSO control box vertically on a wall in an area protected from freezing conditions.

---

Note:

If the controls are not mounted vertically, the filter float drains may leak air or fail to function.

---

**STEP 2 - Attach Tank-Full Shut-Off (TFSO) Tank Unit**

- a. Thread the TFSO tank unit (it need not be air tight) into a 2-inch NPT fitting on the top of the recovery tank. The TFSO tank unit has 2-inch straight threads and should screw deeply into a standard 2-inch NPT coupling. (See Figure 2)
- b. Ensure that the float and sensor tube extends down into the tank sufficiently so that it can be reached by the rising liquid before the tank is full or it overflows.

---

Note:

Optional float units can be added to other liquid tanks such as water tanks, surge tanks or oil and water separators. The dual TFSO sensor hose would be teed from the TFSO tank unit. (See Figure 2)

---

**STEP 3 - Attach Dual Tank-Full Shut-Off (TFSO) Hose (gray)**

- a. Attach the dual TFSO sensor hose to the control box and the TFSO unit . (See Figure 2)

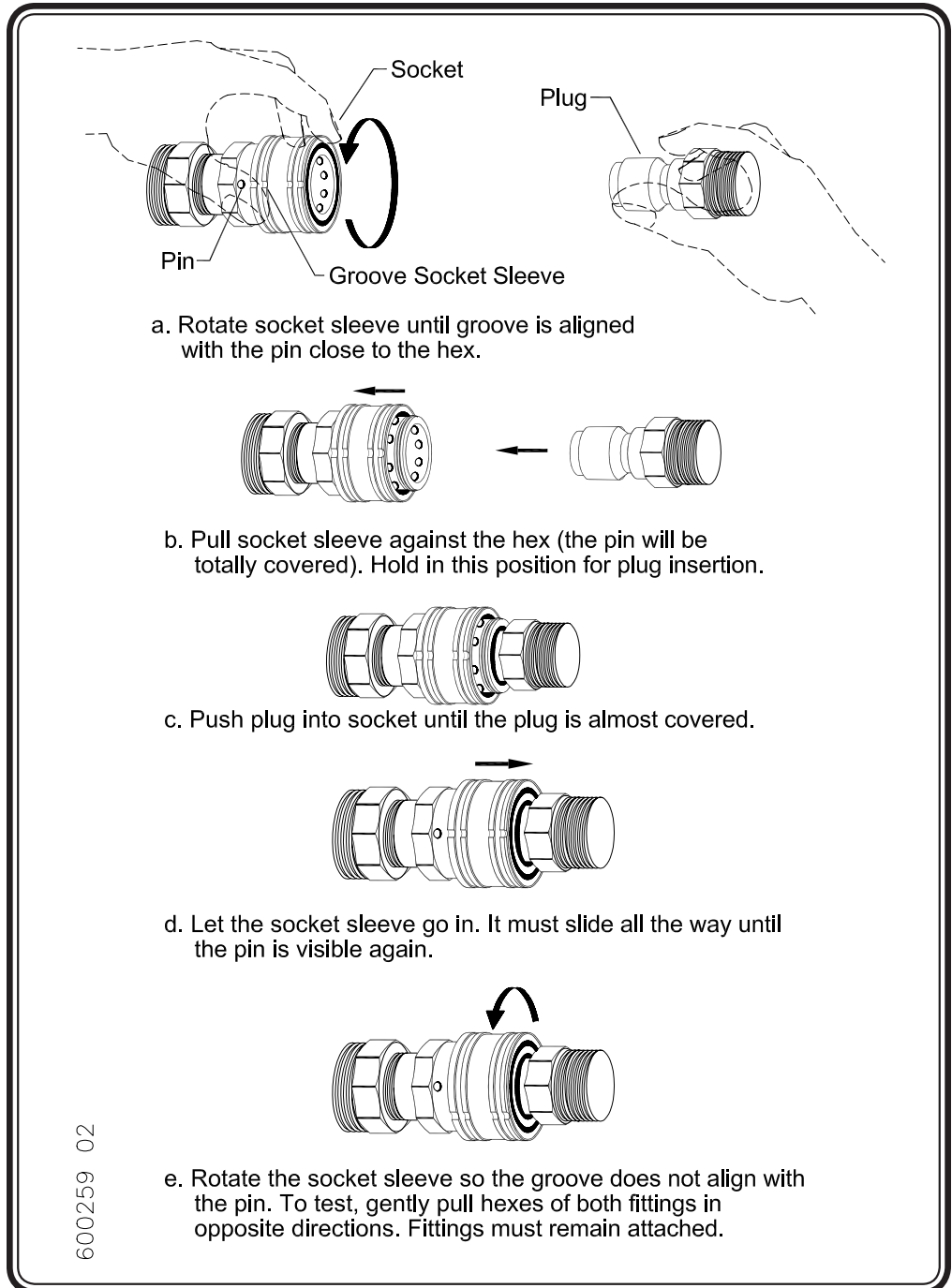

**Figure 1 - Locking Quick-Connect Instructions**

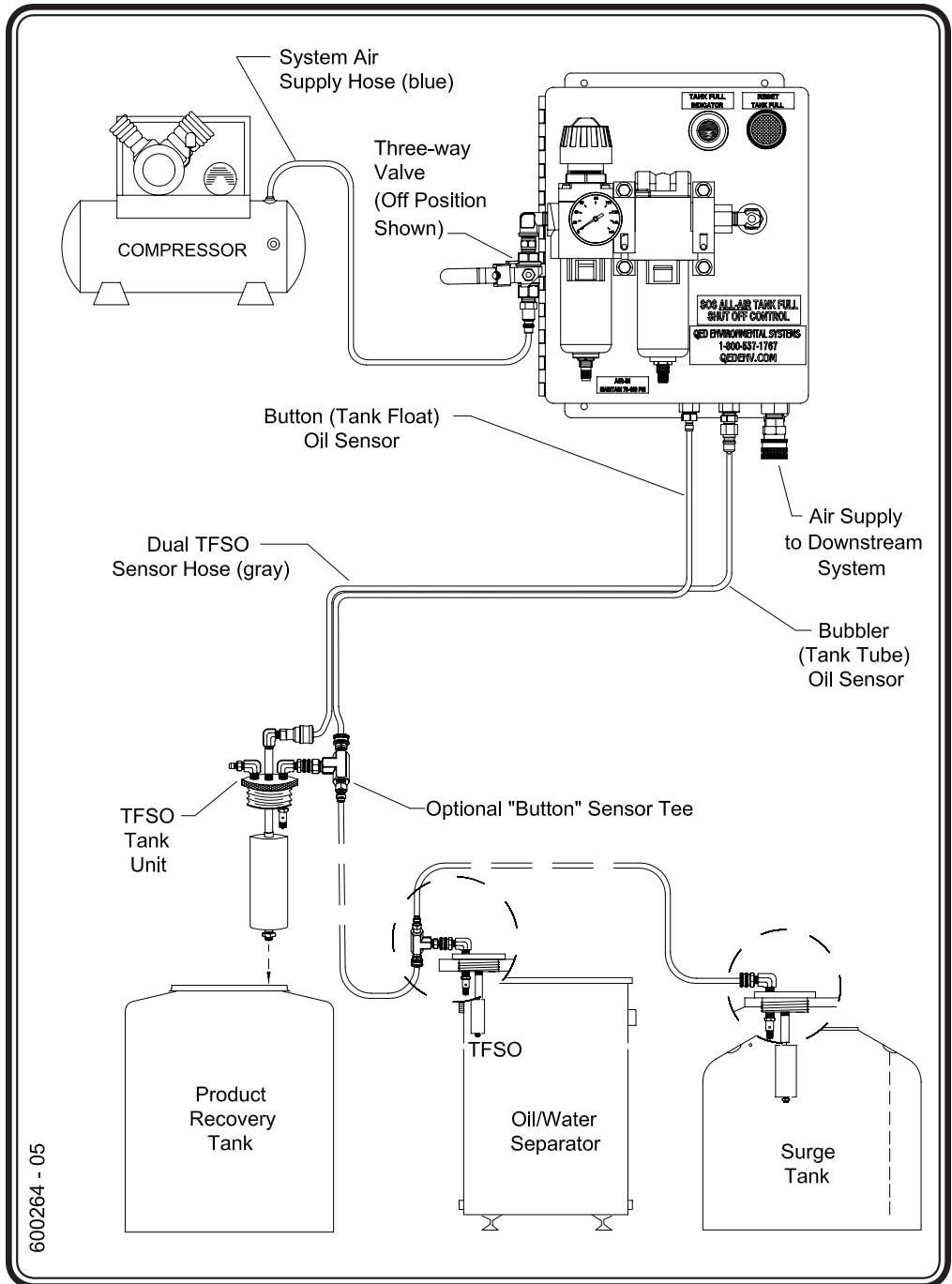

Figure 2 - Wall-Mount TFSO Assembly with Button Sensor Tee

**b. TFSO Button/Float Sensor tee**

If more than one recovery tank is used, attach the TFSO button/float sensor tee fitting (the quick-connect without the internal valve) to the TFSO button/float sensor oil sensor fitting on the TFSO tank unit.

(See Figure 2)

- c.** Attach the male fitting of the dual TFSO sensor hose (for TFSO button/float sensor) to the female fitting of the TFSO button/float sensor tee.

Extend additional TFSO sensor hose from the remaining male fitting of the tee to other tanks if more than one tank is required.

If three tanks are used, the first two tanks require TFSO button/float sensor tees.

---

**WARNING:**

Only tee from the quick connects that do not have internal valves. These fittings are labeled with ST (for straight through). If you tee off tank sensor units using the fittings with the internal valves, the system will not shut down until all the tanks are full, in that case one or more tanks may overflow.

---

- d.** Arrange the hoses so any water that condenses in them will drain to the TFSO unit in the tanks. (See Figure 2)

---

**WARNING:**

If there is a dip in the hoses and water collects there, it may interfere with the operation of the TFSO System.

---

**STEP 4 - Attach Pump Air hose**

Attach the downstream pump air hose to the control box and the downstream system. (See Figure 3)

**STEP 5 - Attach System Air Supply hose (blue)**

Attach the system air supply hose to the air compressor and the control box. (See Figure 3)

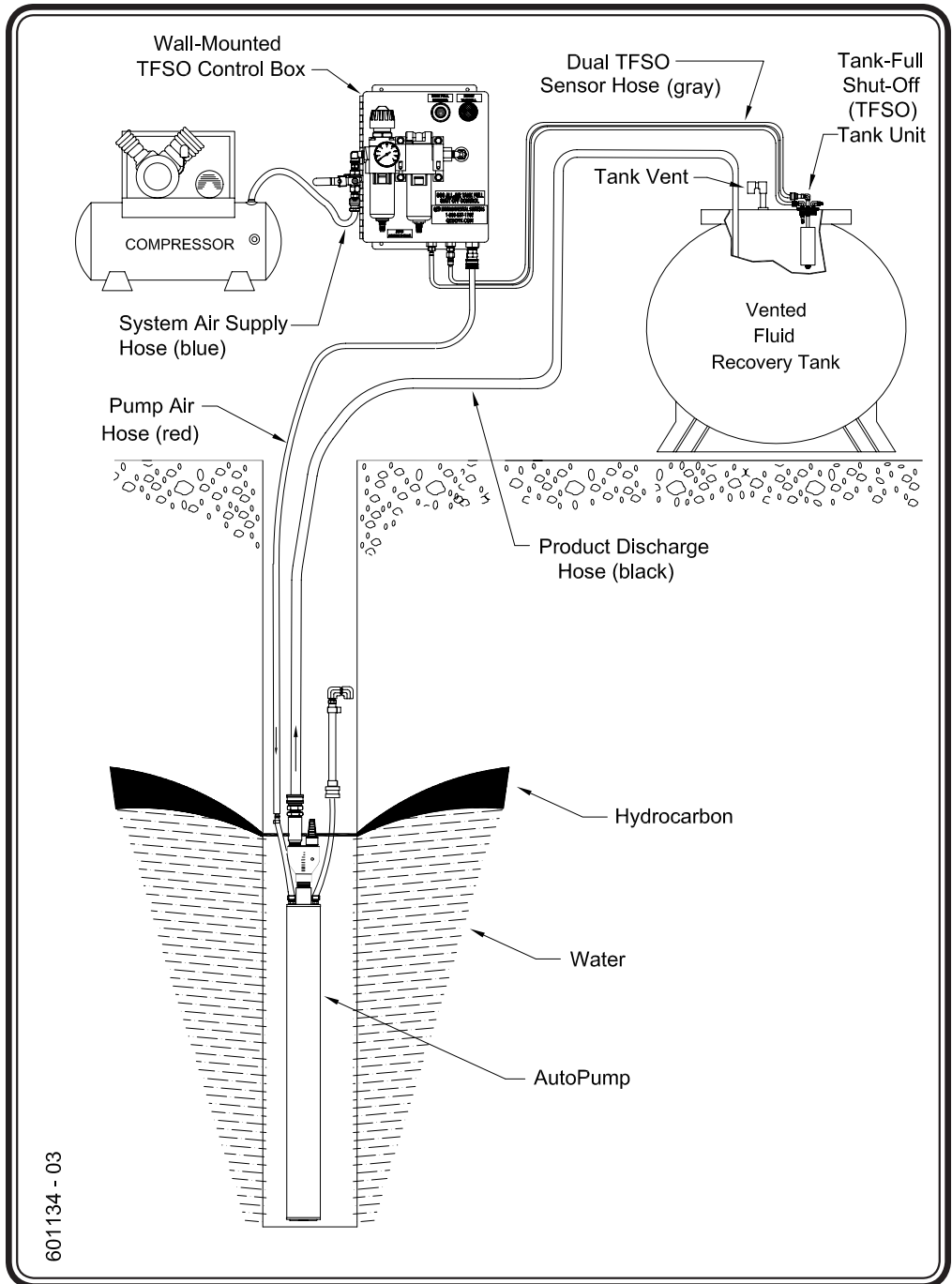

Figure 3 - Wall-Mount TFSO with AutoPump Downwell System

**STEP 6 - Attach Optional Tank Adapter/Vent**

Thread the tank adapter into a 3/4 inch NPT fitting on the top of the recovery tank. (See Figure 3)

**STEP 7 - Install Fume Return/Overflow hose (gray)**

Attach the fume return/overflow hose to the tank adapter via hose barb and clamp or the TFSO tank unit. (See Figure 3)

## Tank-Mount TFSO System

**STEP 1 - Install the TFSO-TM Control**

Thread the TFSO-TM Control (it need not be air tight) into a 2-inch NPT fitting on the top of the recovery tank. The TFSO-TM Control has 2-inch straight threads and should screw deeply into a standard 2-inch NPT coupling. (See Figure 4)

**STEP 2 - Attach Pump Air hose**

Attach the downstream pump air hose to the control box and the downstream system. (See Figure 4)

**STEP 3 - Attach System Air Supply hose (blue)**

Attach the system air supply hose to the air compressor and the control box. (See Figure 4)

**STEP 4 - Attach Tank Adapter/Vent**

Thread the tank adapter into a 3/4 inch NPT fitting on the top of the recovery tank. (See Figure 4)

**STEP 5 - Install Fume Return/Overflow hose (gray)**

Attach the fume return/overflow hose to the tank adapter via hose barb and clamp or the TFSO tank unit. (See Figure 4)

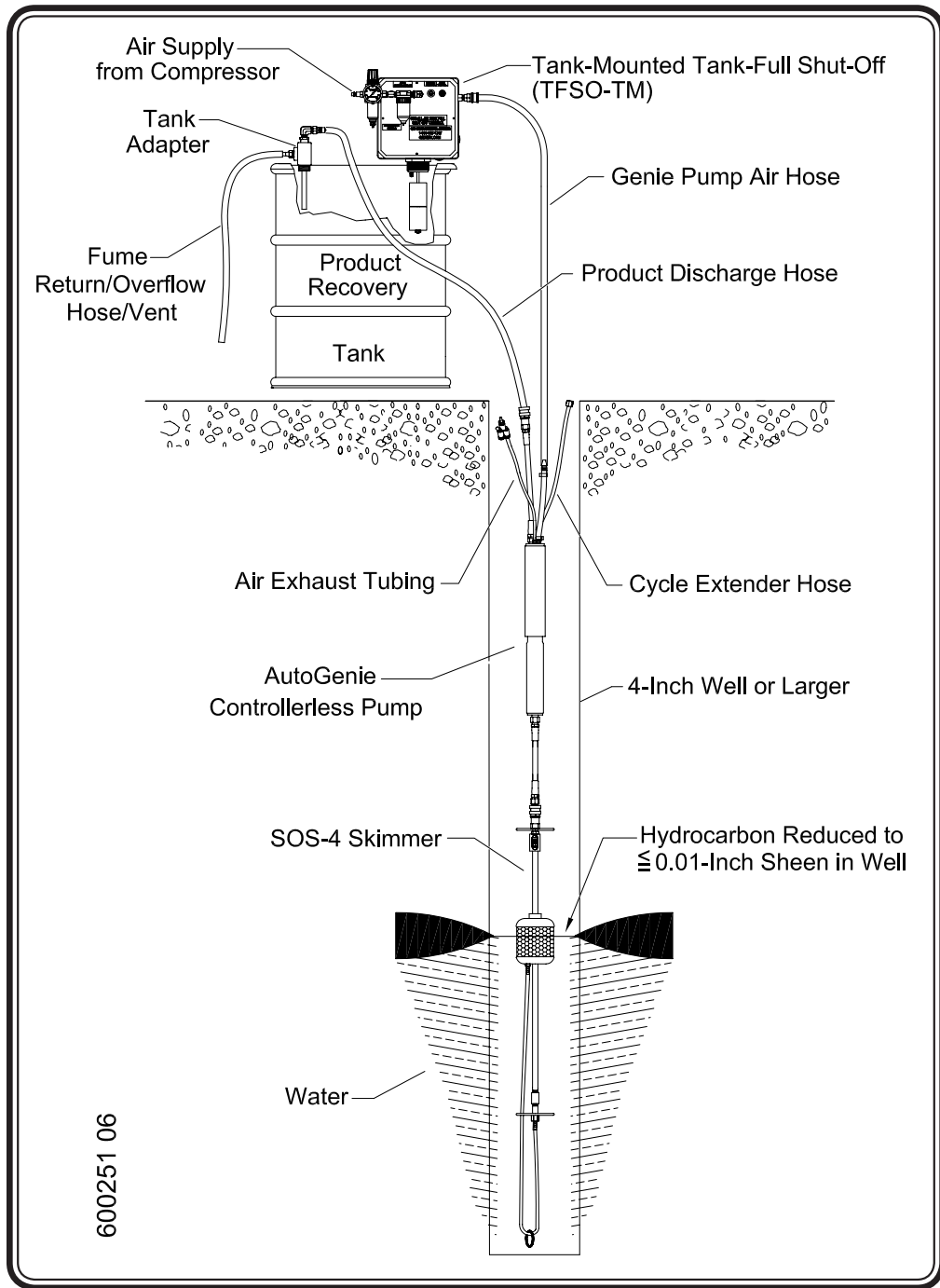
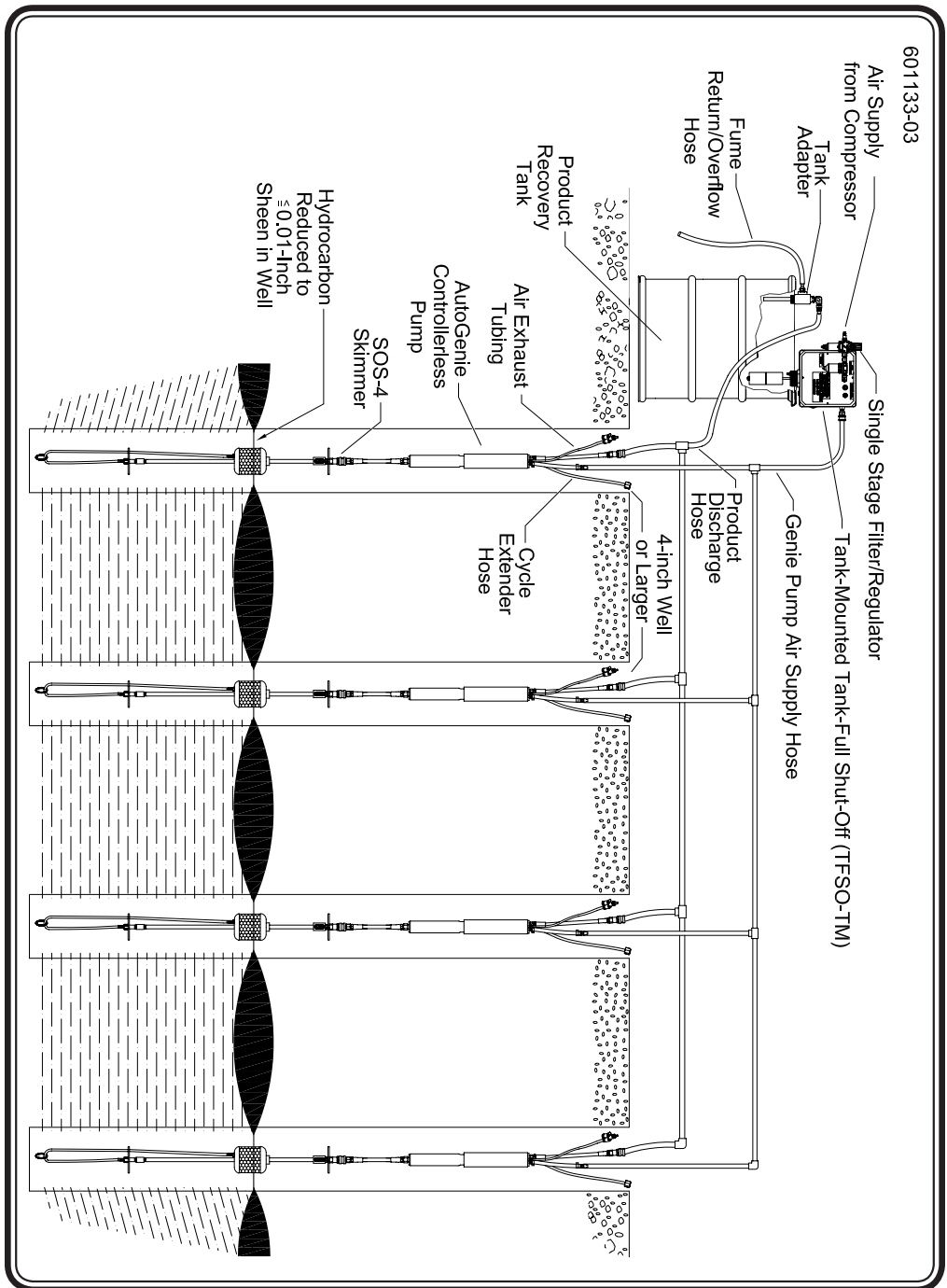

Figure 4 - Tank-Mount TFSO with AutoGenie and SOS-4 System



**Figure 5 - Multi-Well AutoGenie System with Tank-Mount TFSO System**



## II. Operation

---

### Start Up Checklist

Ensure that the following conditions exists:

1. Personal Protective Equipment (PPE) is being used by all personnel.
2. On Wall-Mount units, the ball valve handle is at 90° to the air flow. This prevents compressed air from entering the controls. On Tank-Mount units, do not connect the controls to a compressed air source until step number 1 under the Start Up Procedure.
3. Rotate the TFSO control air pressure regulator knob counter-clockwise until it stops. To unlock the knob turn the plastic nut on top counter-clockwise. On the Tank-Mount TFSO pull the knob upwards.
4. Check that the compressor is regulated to between 70 and 150 psi.
5. All sensor and downstream hoses are connected.
6. The exterior air filter is mounted vertically to allow the filter and its bowl drain to operate properly.
7. All out-of-well air and fluid valves are in their correct positions.
8. A method of rapid disconnect and exhaust (or at least a shut off) of compressed air to the pump is available in case of an unexpected occurrence. For Wall-Mount units this is the 3-way ball valve or the supply air quick-connect. For Tank-Mount units this is the air supply quick-connect.

### Start Up Procedure

- 
- STEP 1-** With the TFSO tank unit now mounted vertically in a vented tank, open the ball valve and allow air to the controls (e.g., rotate the handle so that it is parallel to the air line). Connect the compressed air source to the Tank-Mount unit.
- STEP 2-** Adjust the TFSO control regulator to between 70 and 100 psi.
- STEP 3-** Press the Tank-Full Reset button. The indicator should turn green.

---

**Caution:**

Air will pass from the TFSO control to whatever equipment is connected to the system. Be ready for the downstream equipment to operate.

---

- STEP 4 -** The TFSO System will operate automatically unless the air supply is removed or a TFSO trip condition exists.

## Observation of System Operation

The TFSO System is designed to pass compressed air to other downstream pneumatic systems as long as a “trip condition” does not exist. If one or more of the conditions listed below exists, the system will close the valve supplying compressed air, exhaust the downstream air, and the indicator will turn red.

## Tank-Full Shut-Off (TFSO) Trip Conditions

The following trip conditions can cause the TFSO System to shut down or remain shut down and register a “tank full” condition. A complete guide to finding and fixing the cause or the shut down is explained in Chapter 4: Troubleshooting & Repair.

- **Liquid level rise in the tank** - The liquid has risen about 4 inches up the float guide tube. This has pushed the float up against the trip button and/or has caused backpressure in the bubbler. Empty the recovery tank.
- **Tank Full Reset button has not been pushed** - You only need to do this when a trip condition has caused a shutdown. The loss of air to the system should not cause a trip and the system should start up when the air supply is restored.
- **Quick connect fittings are not connected (Wall-Mount(s) only)** - Two sets of quick connects on each end of the TFSO sensor hoses must be fully pushed into each other. Check all fittings.
- **Leak in the button/float hose or fittings** - If air pressure cannot be held behind the button, the system will shut down. This may result from a cut in the TFSO sensor hose, or debris in the sensor switch. Inspect both hoses and verify that they are clear of obstructions and damage, and check that the O-rings are in the quick connects.

- **Blockage in the bubbler/tube hose or fittings** - If pressure in the bubbler/tube builds to 3 or 4 inches of water pressure, the system will shut down. This can be caused by condensate collecting in a dip in the tubing. Blow out the sensor tubing.
- **Tank vent is plugged or too small** - Pressure can build up in the recovery tank and as a result the tube can sense the back pressure and shut down the system.
- **The control exhaust is blocked** - Make sure that the control exhaust is not pressing against material which could block the exhaust from the control box.

## Resetting

Once the tank full indicator has been tripped, it must be manually reset using the Tank Full Reset button on the cover of the control box. Determine the cause of the problem, correct it, and then press the reset Tank Full Reset button.

## Resiliency Feature

If supply air is lost (e.g., compressor shut down at night), the TFSO System stops functioning, but does not “trip”. The tank full indicator turns red due to low air pressure, not a “trip”. When the air supply is restored (e.g., morning start up of the compressor), the indicator should return to showing green and the controls should resume functioning as if nothing had occurred.

## Overflow Fail Safe

In the unlikely event that both sensors fail, the fume return/overflow hose ensures that excess product is pumped back into the well. You should periodically check that the recovery tank is not full and that fluid is being removed rather than recycled.

## Special Operating Conditions

Conditions may exist that require adjustment or adaptations to the equipment. Below is a list for some of these conditions, their possible effects, and a brief description of an adjustment which may solve the problem.

Since every site is different, please contact your *QED* representative for detailed assistance if needed.

## Cold Weather Conditions

Freezing conditions may cause problems that could that require assistance from your *QED* representative.

Under cold weather conditions, moisture in the pneumatic lines can freeze causing problems with the system. If you are operating the system in freezing weather, you should take precautions to avoid this.

### Actions To Take

- Use water traps and automatic compressor tank drains. These are available at industrial distributing companies (e.g., W.W. Graingers®).
- Bury air hoses below the frost line. Insulate and heat with heat tape or run through a PVC pipe with warm air being blown through it.
- Remove all the moisture you can from the air by using drains on the compressor, filter, and low points in the air line. Use an electrical or desiccant air dryer, and pull only cold, dry air into the compressor.
- During freezing conditions regulators may fail “open”, allowing high pressure (e.g. 150 psi from the compressor) to enter components (e.g. gauges, hoses, fluid receptacles) that may be damaged, cause a safety problem, or release contaminating material. Be sure the regulator is protected from freezing.
- Make sure the control box is protected from freezing conditions. If possible, maintain the temperature above 45° F—since air expansion causes a temperature decrease. Other adverse conditions such as rain, dust and vibration usually have little or no effect on the system.

---

#### **WARNING:**

The Tank-Mount TFSO should not be placed on a tank in an area that may experience close-to-freezing temperatures.

---

- The air compressor can be placed in a small, insulated enclosure along with the control box. The heat generated by the compressor may be sufficient to maintain 45° F or greater within the enclosure.

- Place the intake to the air compressor outside of its enclosure to ensure only low moisture air (cold air) is drawn into the compressor. The intake must be arranged so rain and runoff do not enter.
- A small explosion-proof electric heater can be used inside a small, insulated enclosure to maintain the temperature at 45° F or above.
- A pneumatic or electric air drier can be installed between the air compressor and control box. This unit reduces the water content of the air so condensation and freezing is reduced significantly. If an electric air drier is used, it must be outfitted with explosion-proof controls or placed away from the product pump and recovery tank.

## High Humidity Conditions

- Use an automatic condensate drain on the compressor (this is recommended for all sites).
- Add an additional automatic float drain for condensate prior to the control box. This could be in the form of a drop leg with an automatic drain at the bottom.

## Chapter 5: Maintenance

### General Maintenance

---

Periodically inspect all hoses and connections for damage. Make sure that the hoses are not split or cracked and listen for leaks in the system. The amplifiers in the control box are supposed to bleed a little air.

Soapy water can be sprayed (using a squirt bottle) on the components and fittings in the control box to locate leaks. Dish detergent in water will not damage the controls. A harsh, concentrated cleaner could damage some portions of the controls.

However, if water enters the control box via the compressed air (from the compressor), it can cause the sensors to malfunction. Such water can be seen as droplets in the air tubing inside the control box. Most of the time this does not cause a problem, but if it does, a clean, dry air source should be used to blow out the tubing. Once the controls begin functioning, check all sensors and allow the control box to operate for a few hours before putting it back into service.

If only a little oil and water enters the air hose, the TFSO System should perform reliably for years. Check the Air filters and filter bowl drains on the filters/regulator for saturation and operation every few weeks.

An automatic drain on the compressor is highly recommended, since such an addition can dramatically decrease air filter maintenance. Automatic drains are available from *QED*.

## Maintenance Table

---

Maintenance is recommended at least once every two weeks, but some site environments may demand more frequent service. The following table outlines the recommended minimum maintenance schedule for the TFSO System.

Maintenance	Weekly	Biweekly	Monthly
<b>Air Quality Check</b> - Two Stage Filter/Regulator - Oil Indicating Filter - Operate Manual Filter Drain	X	X X	
<b>Tank-Full Shut-Off (TFSO) Test</b>	X		
<b>Control Leak Check</b>			X

The following sections describe each of these maintenance activities in detail.

### Two Stage Filter/Regulator

---

If the incoming air is clean and dry, the TFSO System should operate trouble-free for years. The filters need servicing when the oil indicating filter in the control box changes from white to pink or brown. This shows that oil or dirty air is getting past the outer air filters, or the filter elements are clogging. The air filters consist of a 5 micron and 0.01 micron (oil coalescing) filter and all have replaceable elements.

To replace the element in the air filters on the two stage filter/regulator use the following procedure:

---

#### **WARNING:**

Always disconnect the air source from the controls before working on either the filters or the controls. Disconnect the blue system air supply hose from the Control box. The air filters will depressurize allowing them to be safely serviced.

---

**STEP 1 - Remove Filter Bowls**

- a. On a Wall-Mount TFSO remove the air filter bowls by sliding the black button downward and twisting the bowl about 1/10 of a turn. The bowl should slide downward from the upper portion of the filter revealing the filter elements. Unscrew the elements as you would unscrew light bulbs. Hand tighten the element after replacing it.

On a Tank-Mount TFSO remove the first filter bowl by twisting and pulling down. Unthread the second filter bowl.

- b. Each filter has its own type of element, and is easily identified. Make sure to replace the correct element.
  - The 5 micron particulate filter is usually white.
  - The 0.01 micron oil coalescing filter is usually red and spongy.

**STEP 2 - Check Float Drains**

- a. Wash out any deposits and oil buildup from the filter bowls with warm water and soap. To make sure the float drains are operating freely, shake them. The drains should rattle. Test the float drains by filling the bowls with water, attaching the bowl to the filter and reconnecting it to the air supply. The water should drain from the bowls.
- b. The filters on the Tank-Mount TFSO are manual drains and must be opened by hand to drain the bowl.

## Oil Indicating Filter

---

To replace the element in the oil indicating filter inside the control box use the following procedure:

**STEP 1 - Remove Filter**

Use a small flat screwdriver to depress the red-collared fitting on the oil indicating filter. Pull the filter out of the fitting. Be careful not to twist and break the plastic stem of the filter.



**STEP 2 - Replace Filter**

To replace the clear filter, press the ends into the red-collared fitting until they *seal*. Use soapy water to check for leaks at filter bowls and connections. If a leak exists at a filter bowl, the O-ring may need service or replacement.

Check the oil indicating filter inside the control box to make sure that it has not changed color from white to pink or brown. If this filter has turned color, this indicates that oil has contaminated the control box and all filter elements must be replaced. Contact *QED Environmental Systems* for a new filter and possible cleaning of the control box.

## Tank-Full Shut-Off (TFSO) Test

---

You should perform the following test at least once per month. This test verifies that the TFSO system will shut down when the recovery tank is full.

- STEP 1 - Wall-Mount System:** Disconnect either sensor hose from the TFSO recovery tank float unit. The TFSO System will shut down. Reconnect the hose.
- STEP 2 -** Wait fifteen seconds. Press the Tank Full Reset button on the control box. The TFSO indicator should shift from red to green.
- STEP 3 -** Disconnect the other hose and repeat STEPS "1 and 2."
- STEP 4 -** Remove the tank unit from the tanks by unscrewing the unit. Reconnect the hoses and reset the controls.
- STEP 5 - Both Wall-Mount and Tank-Mount Systems:** Check that the float can travel freely. Press the float against the button switch. The system should shut down within fifteen seconds.
- STEP 6 -** Allow the float to fall away from the switch. Wait fifteen seconds. Press the Tank Full Reset button on the control box. The unit should reset.

- 
- A vertical bar consisting of three parallel lines, with the leftmost line being the thickest and the two on the right being thinner. It runs vertically along the left side of the step list.
- STEP 7 - Both Wall-Mount and Tank-Mount Systems:** Hold the float away from the switch and submerge the end of the bubbler tube (bottom of float) under 4 inches of water. The system should shut down when the end of the tube is 3 to 4 inches under water.
- STEP 8 -** Remove the tube from the water, press the Tank Full Reset button on the control box, and it should reset.
- STEP 9 -** Repeat STEPS "3 and 4" for any float units teed on the button switch line.
- STEP 10 -** Replace all units in their tanks and reset the control.

If you encounter problems in any portion of this test, refer to the troubleshooting chapter.

## Chapter 6: Troubleshooting & Repairs

Problems may occur and usually can be easily resolved by following these instructions. If, after careful reading and service, you cannot resolve the problem, please call the *QED Environmental Systems (QED)* Service Department at (800) 537-1767.

### Troubleshooting

---

#### **Problem: Tank Full Shut-Off (TFSO) Will Not Reset**

**Quick Reference:** The following items can cause the TFSO not to reset. An in-depth system analysis follows the quick reference.

- Recovery tank is full.
- Tank Full Reset button has not been pushed.
- Quick connect to TFSO sensor fittings are not connected.  
(Wall-Mount(s) Only.)
- One or both tank full sensor hoses are damaged or pinched.  
(Wall-Mount(s) Only.)
- Tank Full Shut-Off (TFSO) tank unit float is jammed against the sensor button.
- Inlet air to the TFSO control box has restricted the air logic.
- Recovery tank vent is plugged or restricted.
- The exhaust is blocked in the control box.
- A fitting or hose is leaking: Check the quick-connect fittings to ensure that the o-ring gaskets are present.

The following is an in-depth approach to solving most problems with the TFSO System. If your problem is intermittent, go to the end of this section where some remedies are listed.

---

Note

Follow these steps in order except where directed to another STEP. (Refer to Figure 7, Figure 8, Figure 9, Figure 10, and Figure 11.)

---

**STEP 1 -** Check if the recovery tank is filled up to the TFSO sensor unit.

If so, empty the recovery tank.

**STEP 2 -** Check that the air to the controls is 70 to 100 psi (regulator outside control box). The low pressure air should read 1.5 psi. If a pressure must be reset and the gauge does *not* respond to a small adjustment of the regulator, replace the gauge.

In the Tank-Mount systems there is no low pressure gauge. To test the sensor pressure in a Tank-Mount system, a low pressure gauge could be threaded onto the end of the sensor tube. It must be removed in order for the system to reset.

Another option is to unthread the button sensor and thread in a barb to connect to a tube leading to a low pressure gauge. This gauge need not be removed to have the system reset when testing the system. Of course it must be removed to operate the system.

**STEP 3 -** Test the accuracy of the low pressure gauge.

With a flat head screwdriver, adjust the low pressure regulator to several pressures between 0 and 4 psi. At each setting wait 15 seconds and then press the Tank Full Reset button for 2 seconds.

If the TFSO *does* reset, replace the low pressure gauge and then readjust to 1.5 psi.

If the TFSO does *not* reset, continue to STEP 4.

**STEP 4 -** Determine if the problem is inside or outside the control box:

- a. Refer to Figure 9 on page 49 and Figure 10 on page 50. Locate the bubbler/tube sensor bulkhead fitting inside the control box. Push in on the red collar and pull the 1/16 inch tubing free.
- b. Press the Tank Full Reset button.

If the TFSSO resets, the problem is *outside* the control box (i.e. in the fittings, hose or sensor unit). Go to Reference section "A" on page 38.

If it does *not* reset, continue to the next step.

- c. Locate the button/float bulkhead fitting inside the box. Release the 1/16 inch tubing by depressing the red collar and pulling on the tube. Inspect the end to be sure it is cut clean and square. Plug the tubing *or* pinch the end with small vice grips. Leave the vise grips on the tubing until this instruction says to release them.
- d. Press the Tank Full Reset button.

If the TFSSO resets, the problem is *outside* the control box. Go to Reference section "B" on page 40.

If it *does not* reset, the problem is *inside* the control box. Continue to the next step.

**STEP 5 -** Gently tap the amplifiers with a screwdriver to free up water droplets that may be clogging a passage.

Press the Tank Full Reset button.

Loosen the mounting screws that hold the amplifiers and tap them again. Push the reset button.

If the control does not reset, continue to the next step.

- STEP 6 -** Immerse the end of the 1/16 inch I.D. bubbler/tube tubing (the piece that is free and was *not* plugged or pinched) in a small amount of soapy water. (It can also be sprayed on the end of the tubing.)
- If there are bubbles, go to STEP 8.
- If there are no bubbles, trace the tubing to the tee on the front of the "010" amp. (See Figure 6)
- STEP 7 -** Continue to follow the tubing to the in-line orifice.
- Remove the tubing from the input end (far side) of the orifice.
- If air comes from the tubing (at about 1.5 psi), replace the orifice.
- If no air comes from the tubing, contact QED.
- STEP 8 -** Trace the tubing back to the "010" amp. (See Figure 6)
- Remove the upper tube of the two tubes on the back of the amplifier.
- If air comes from the fitting (from where the tube was removed), replace the amplifier. After replacing the amplifier, continue with STEP 9.
- If *no* air comes from the fitting, reconnect the tubing and continue with STEP 9.
- STEP 9 -** Remove your plug (STEP 4c) from the end of the 1/16 inch I.D. button /float tubing leading to the "011" amplifier.
- STEP 10 -** Immerse the end of the tubing in a small amount of soapy water. (It can be sprayed on the end of the tubing.)
- If there are bubbles, go to STEP 12.
- If there are no bubbles, replace the plug in the tubing, then trace the tubing to the "011" amplifier.

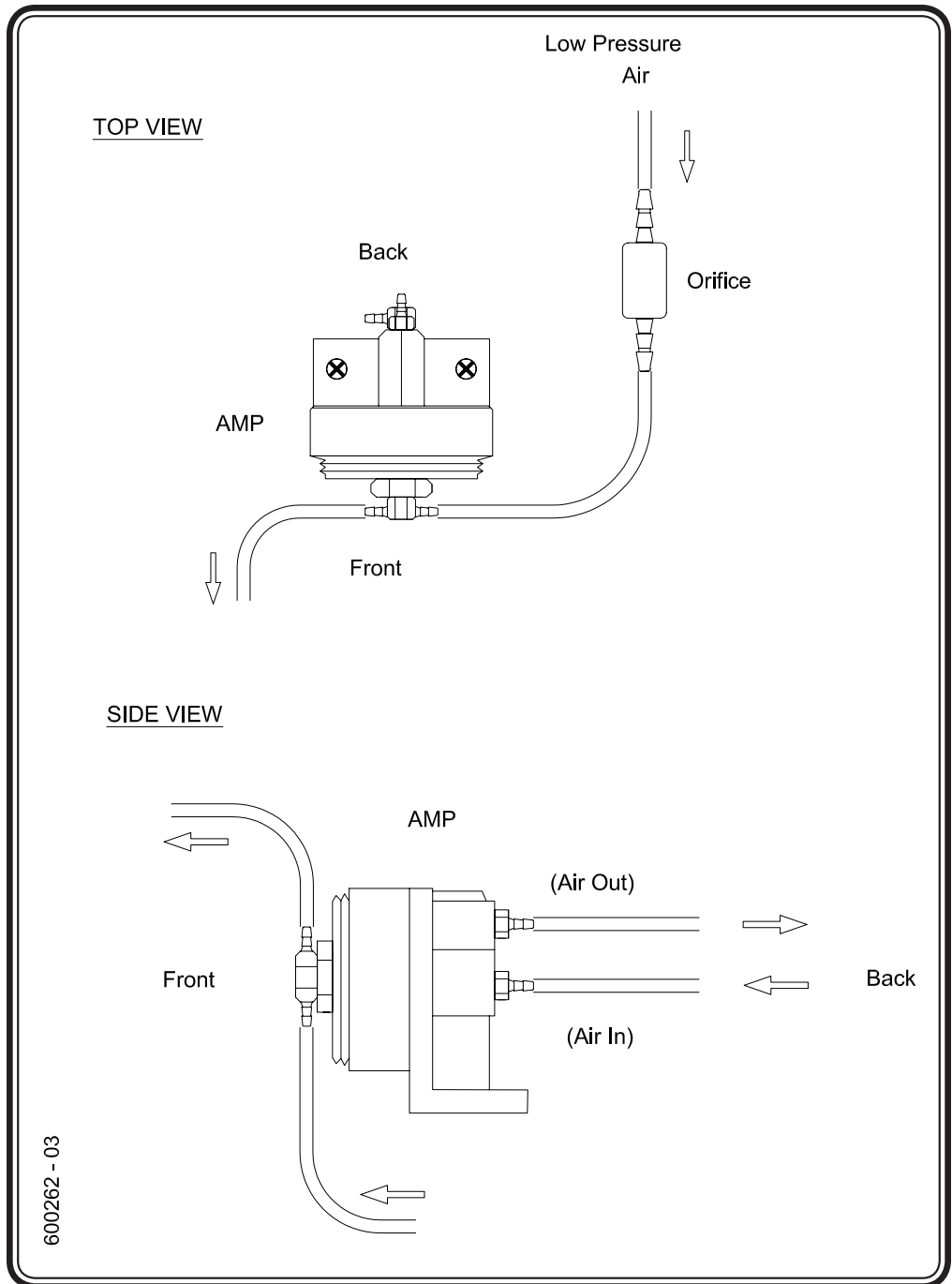

Figure 6 - Amplifier

**STEP 11 -** Continue following the tubing from the tee in front of the amplifier to the in-line orifice.

Remove the tubing at the input end (far side) of the orifice.

If air comes from the tubing, replace the orifice. After replacing the orifice, go back to STEP 10.

If no air comes from the tubing, contact *QED*.

**STEP 12 -** Trace the tubing back to the "011" amplifier.  
(See Figure 6)

Remove the upper tube of the two on the back of the amplifier.

If there is *not* a steady stream of air from the fitting, replace the amplifier.

**STEP 13 -** Reconnect the tubing at the back of the amplifier.

**STEP 14 -** Press the Tank Full Reset button.

If the TFSO does *not* reset, contact *QED*.

If the TFSO *does* reset, remove the plug that you installed in the 1/16 inch button/float tubing. Reconnect the sensor tubing ends to the correct bulkhead fittings.

## Reference A

(From STEP 4b, and from STEP G in Reference B.) (TFSO problem is outside the control box and is on bubbler circuit).

- a. See if there is a clog or obstruction in the red collared bulkhead fitting by inserting a paper clip or nail through the fitting.
- b. Insert the tubing back into the red collared bulkhead fitting. Make sure the tubing is seated by pulling gently on the tube. It should not come out of the fitting.



- c. Make sure that the recovery tank is vented to atmosphere. A small back pressure (3 inches H<sub>2</sub>O) can trip the TFSO bubbler/tube circuit.

The fume return/overflow hose barb can be removed from the tank adapter to provide a vent. If an overflow hose and a vent are required, a tee can be attached to the tank adapter with one opening used as an elevated vent (three feet above the tank) and the other as the attachment to the overflow hose.

- d. Check that the bubbler/tube line along its entire length is not crimped or kinked. Check that all quick connects have O-rings in the sockets. (Wall-Mount(s) Only.)
- e. Disconnect the bubbler/tube socket from the fitting on the control box. (Wall-Mount Only.)
- f. Connect a loose, open-ended quick connect mate to the socket *or* simply unscrew the socket from the hose barb. (Wall-Mount Only.)
- g. Unscrew the TFSO tank unit from the recovery tank and then reattach the quick connects. (Wall-Mount(s) Only.)
- h. Blow out the bubbler/tube line and the tank unit tube section with compressed air. A clog or water condensation in the line may have tripped the TFSO. (Wall-Mount(s) Only.)
- i. Reinstall the TFSO tank unit. (Wall-Mount(s) Only.)
- j. Reconnect the sensor line to the control box and the TFSO tank unit. (Wall-Mount(s) Only.)

Press the Tank Full Reset button.

If the TFSO does *not* reset, contact QED.

## Reference B

(From STEP 4d) (TFSO problem is outside of the control box and is on the button/float circuit alone, or it is also on the bubbler circuit alone, or it is also on the bubbler circuit.)

- a. Remove the plug from the 1/16 inch I.D. tubing and reinsert the tube into its red collared fitting. Make sure the tubing is seated by pulling gently on the tube. It should not come out of the fitting.
- b. Check for leaks in the button/float line and all connections, including the red collared control fitting. A solution of mild soap and water may be applied to see if bubbles appear. If bubbles do appear at the quick connect fittings, check for missing O-ring in the quick connect socket.
- c. Unscrew the TFSO tank unit from the recovery tank. Reconnect the sensor line fittings. (Wall-Mount(s) Only.)
- d. Make sure that the float is not jammed against the button switch.
- e. Submerge the entire tank sensing unit in six inches of water while holding the float away from the button switch.  
(Wall-Mount Only.)

Fix any leaks in the fittings.

Replace the button switch if it leaks.

- f. Reinstall the TFSO tank unit in the tank and push the Tank Full Reset button.

If the TFSO does *not* reset, contact QED.

If the TFSO *does* reset, reconnect the 1/16 I.D. tubing at the control that inserts into the bubbler/tube red collared fitting.

- 
- g. Press the Tank Full Reset button.

If the TFSO *does not* reset, disconnect the 1/16 I.D. bubbler/tube tubing from its red collared fitting.

Go to Reference section "A," on page 38.

## Intermittent Problems

If the system functions well for a period and then shuts down, the problem may be one that develops over time. Below are some possible scenarios and corrections to such problems.

If the TFSO resets and then later, after the pump has cycled a few times, trips for no apparent reason, ensure that the tank is vented with at least a 3/8-inch I.D. hose. Ensure that there are no restrictions or water trapped in the tank vent.

Ensure that no tubing is pinched when the lid of the control box is shut. Such pinching could slowly starve the logic system and eventually cause a shut down.

## Returning Equipment for Service

---

If the equipment needs to be returned to *QED* for servicing, please follow these steps:

- STEP 1 -** Call the *QED* Service Department and obtain a Return Material Authorization (RMA) number. Please have available the customers contact person's name, company name and address, phone number, fax number, reason for the return, and the names of the chemicals to which the equipment has been exposed.
  
- STEP 2 -** Clean all equipment before shipping. See **Equipment Cleaning Requirements** at the end of this section.  

If the equipment must be cleaned after it arrives at *QED*, the customer will be charged for the cleaning and disposal of material, if necessary. (Cost can be \$200.00 per piece of equipment cleaned.) Drain and dry all equipment after cleaning.
  
- STEP 3 -** Package the equipment so that it will not be damaged in shipment. Use bubble pack rather than styrofoam flakes as packing material.
  
- STEP 4 -** Ship the equipment via a carrier and service level (i.e., one-day, two-day shipping) in consideration of probable service time and return shipment time.
  
- STEP 5 -** It is recommended that such shipments be insured so if the shipment is badly damaged or lost, the customer can replace the equipment at little or no cost.
  
- STEP 6 -** Include the contact's name, company, phone number and RMA number given by *QED*.
  
- STEP 7 -** Write the RMA number on the outside of the packaging so it will be directed immediately to the *QED* Service Department.

## Equipment Cleaning Requirements

---

If the equipment is to be shipped to another site or to the factory for service, it needs to be thoroughly cleaned before leaving the site. Cleaning the equipment protects the user (sender), the shipper, and the receiver from dirt and/or contaminants. If the equipment is not cleaned prior to shipping for servicing, it may be severely delayed, refused or the shipper may be charged a cleaning fee. Before packing and shipping, ensure that the equipment is dry inside and out.

The following is a list of equipment and how it should be cleaned prior to shipment.

### Hoses and Fittings

- 
- STEP 1** - Pump clean water or water with a gentle soap solution (e.g. Dove Dish Soap) through the pump to remove free product and particles.
  
  - STEP 2** - Rinse all soap off of the equipment.
  
  - STEP 3** - Soak and rinse the outside of the unit with water to remove loose debris and dirt.
  
  - STEP 4** - Steam clean inside and out to remove difficult dirt and contaminants.

---

**Caution:**

Use low pressure (less than 40 psi) when steam cleaning.

---

# Appendix A: Equipment Specifications

## Equipment List

---

The equipment list will vary depending on site specifications, but the following lists are typical configurations:

### **Wall-Mount TFSO System**

1. TFSO control box
2. TFSO tank unit
3. Tank Adapter
4. Hoses/Tubing:
  - Dual TFSO sensor\*
  - Fume return/overflow
  - System air supply

\*This is composed of two tubings. For lengths up to 75 feet, each hose is 1/8-inch I.D. . For lengths between 75 feet and 300 feet, the I.D. is 1/4-inch. For lengths from 300 feet to 1,000 feet, the I.D. is 3/8-inch.

### **Wall-Mount HIGH FLOW TFSO System**

1. TFSO control box
2. Special High Flow Valve and Wall Mount Filter/Regulator Assembly
3. TFSO tank unit
4. Hoses/Tubing:
  - Dual TFSO sensor\*
  - Fume return/overflow
  - System air supply

\*This is composed of two tubings. For lengths up to 75 feet, each tube is 1/8-inch I.D. For lengths between 75 feet and 300 feet, the I.D. is 1/4-inch. For lengths from 300 feet to 1,000 feet, the I.D. is 3/8-inch.

## Tank-Mount TFSO System

1. TFSO-TM control box
2. Tank Adapter
3. Hoses:
  - Fume return/overflow
  - System air supply

## Options and Accessories

Contact your *QED* Representative regarding the following:

- Tank adapter
- Downstream equipment air supply hose
- Two stage filter/regulator
- Single sensor TFSO tank units for multiple tanks
- Remote monitoring
- TFSO tank units of various lengths to accommodate different size tanks
- Multi-well systems (See Figure 2)
- Locking features on quick-connects to prevent accidental parting of connections.

## Tool List

- Screw driver

## Recommended Spare Parts List

The parts that can be anticipated replacing are:

- Filter elements
- Amplifiers (if fouled with oil)

## Component Materials

- Stainless Steel
- Brass
- Viton
- Nitrite
- PVC
- Aluminum

---

## Components and Functions

---

*The following sections describe each of the basic components and the applications used to operate them.*

### **TFSO Control Box**

The rain-tight control box (also known as the enclosure) protects the pneumatic logic. (See Figures 7, 8, 9, 10, 11, and 12)

### **Oil Indicating Filter**

The oil indicating filter is located on the air tubing that further cleans the air passing to the timers. This filter indicates the presence of oil and if contaminated, it will turn pink or brown. Replace the filter immediately if it is pink or brown. In addition, the filter wrinkles when there is moisture. (See Figures 8, 10, and 12)

### **Two Stage Filter/Regulator**

Two filters mounted outside the control box remove particles and some oil vapor, and water droplets from the air passing to the downstream components. The regulator should produce at least as much pressure and flow as required by the downstream equipment. (See Figure 7, 9 and 11)

### **Two Stage Filter/Regulator with Special High Flow Valve**

Same characteristics as above, but with larger filters and a special high flow valve capable of sending up to 47 scfm of air to multiple wells.

#### **5 Micron Particulate Filter**

The 5 micron filter is the first filter in line and connects to the system air supply. On the Wall-Mount system the filter has an automatic float drain. On the Tank-Mount system the filter has a manual drain. (See Figures 7, 9 and 11)

#### **0.01 Micron Oil Coalescing Filter**

The 0.01 micron filter is the second in line and it removes very fine droplets and particulates. On the Wall-Mount systems the filter has an automatic float drain that activates when the fluid level rises in the filter bowl. This filter has a visual indicator that turns red when the filter element is clogged. On the Tank-Mount system the filter has a manual drain. (See Figure 7, 9 and 11)



## Tank Full Indicator

The system is ON when the indicator is green. When the indicator is red, the entire system shuts down to prevent overflow of fluid from the tanks. Air is prevented from flowing to downstream equipment which is pumping fluid into the tanks. (See Figures 7, 9, and 11)

## Reset Tank Full Button

This button is pressed to reset the controls after the cause for the “activation” is remedied. (See Figures 7, 9 and 11)

## Tank-Full Shut-Off (TFSO) Tank Unit

*This unit is incorporated into the Tank Mount Control Box*

The TFSO tank unit mounts in a 2-inch NPT fitting in the product storage tank. The end points of both the TFSO bubbler/tube sensor and the TFSO button/float sensor are located on the TFSO tank unit. The controls bleed a small amount of air into the hoses connected to each sensor. This creates the bubbler and the pressure behind the button switch. (See Figures 9 and 13)

### TFSO Bubbler/Tube Sensor

The TFSO bubbler/tube sensor is the float guide rod tube on the TFSO tank unit. As air exits the bottom of the tank unit, it bubbles into the rising fluid. When 3 to 4 water column inches of pressure develops, the circuit trips and shuts down the system. (See Figures 9 and 13)

---

Note:

If the recovery tank is not properly vented, this sensor may shut the control down due to a slight pressure build up in the tank.

---

### TFSO Button/Float Sensor

The TFSO button/float sensor retains 1.5 psi in the hose. This should not be changed without express written approval from the factory. This sensor causes the system to “trip” when the float on the TFSO tank unit rises up against the button and causes a release of pressure in the air hose. (See Figures 9 and 13)

When several TFSO button/float sensors are teed on the same line for multiple tanks, it only takes one to be tripped to release the pressure in that side of the controls and instigate a trip. Additional TFSO bubbler/tube sensors cannot be teed on the system because they would only cause a trip when all of the TFSO bubbler/tube sensors felt a back pressure at the same time.

---

Note:

Multiple tank monitoring is only available with the Wall-Mount designs (See figure 2).

---

A fume return/overflow hose is attached to the TFSO tank unit (Wall-Mount Only.) The other end of this hose should be placed in a drum or the well. This hose will vent fumes as the recovery tank is emptied, and should always be placed in a safe, spark-free environment. The fume return/overflow hose will also carry excess product if the TFSO tank unit fails and the recovery tank is full.

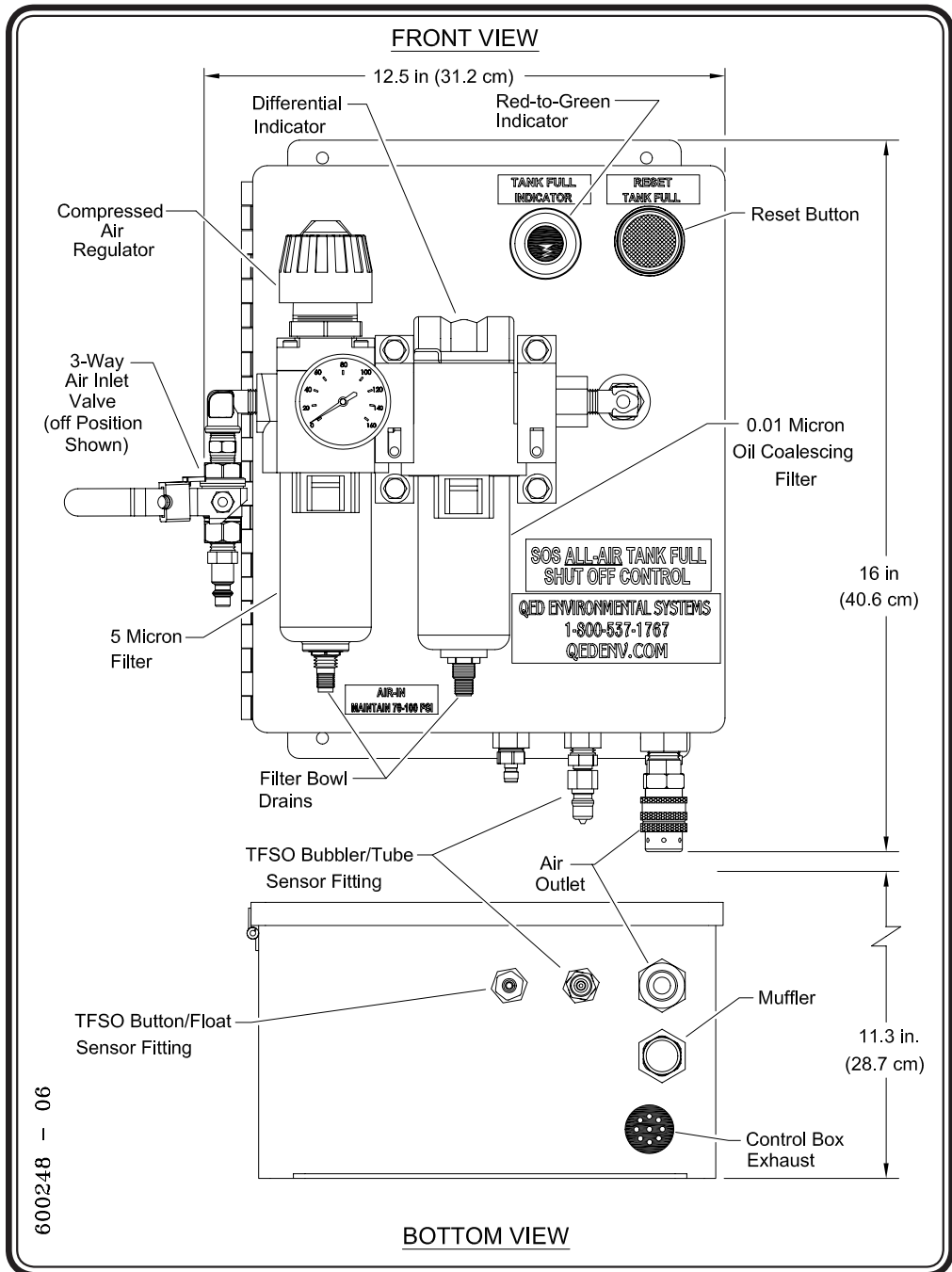

Figure 7 - Wall-Mount Control Box Exterior

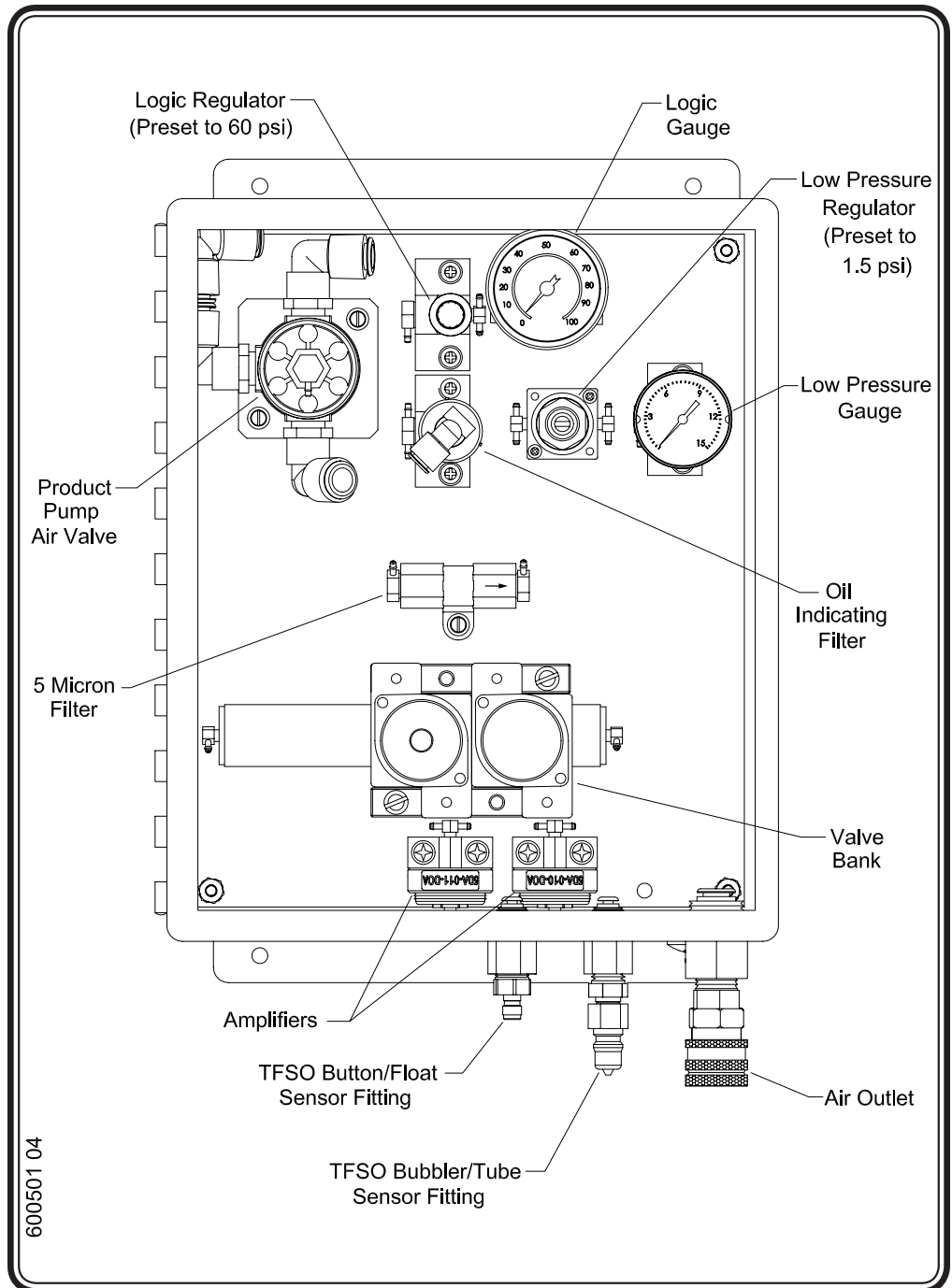

Figure 8 - Wall-Mount Control Box Interior

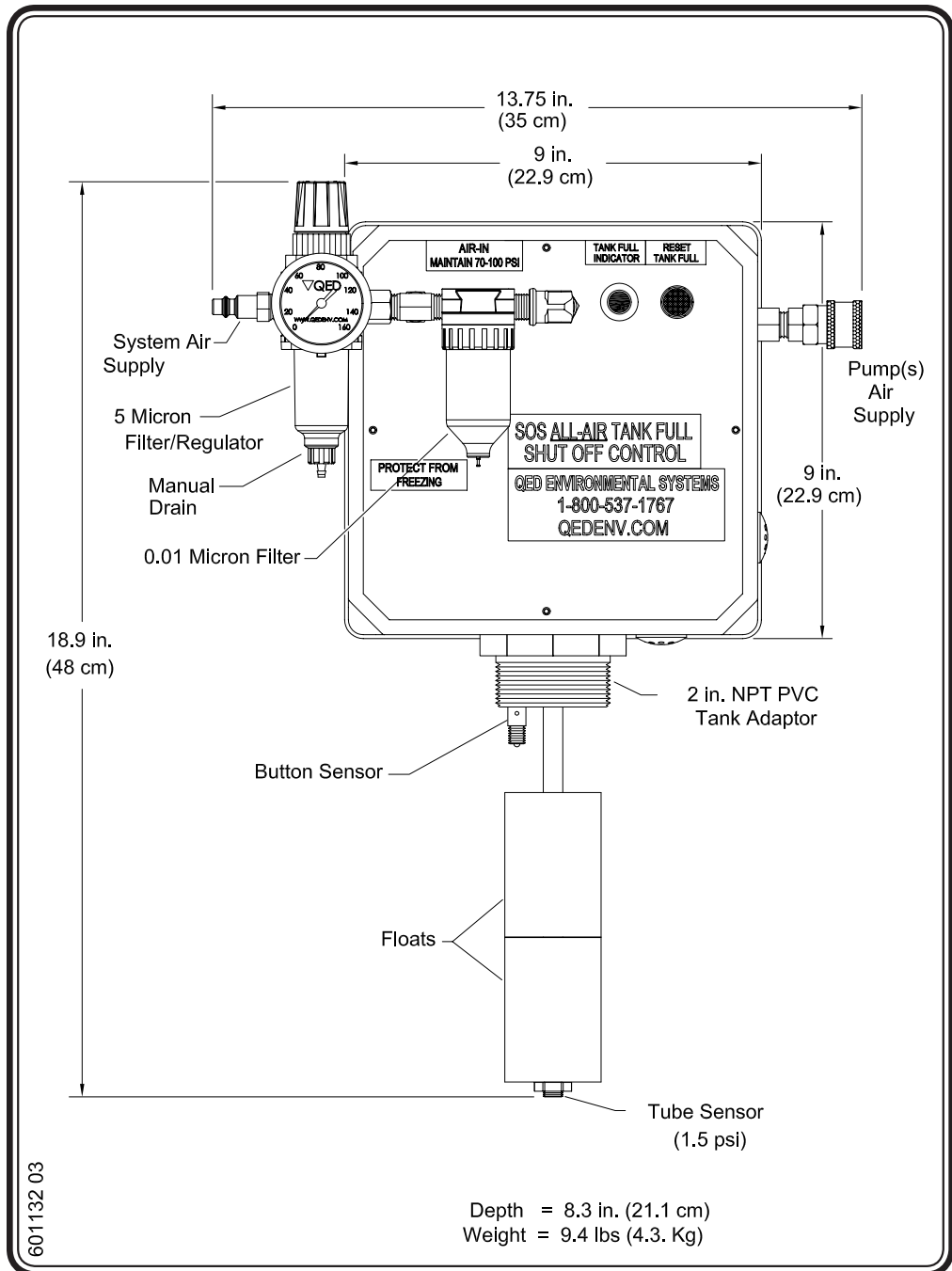

Figure 9 - Tank Mount-Control Box Exterior

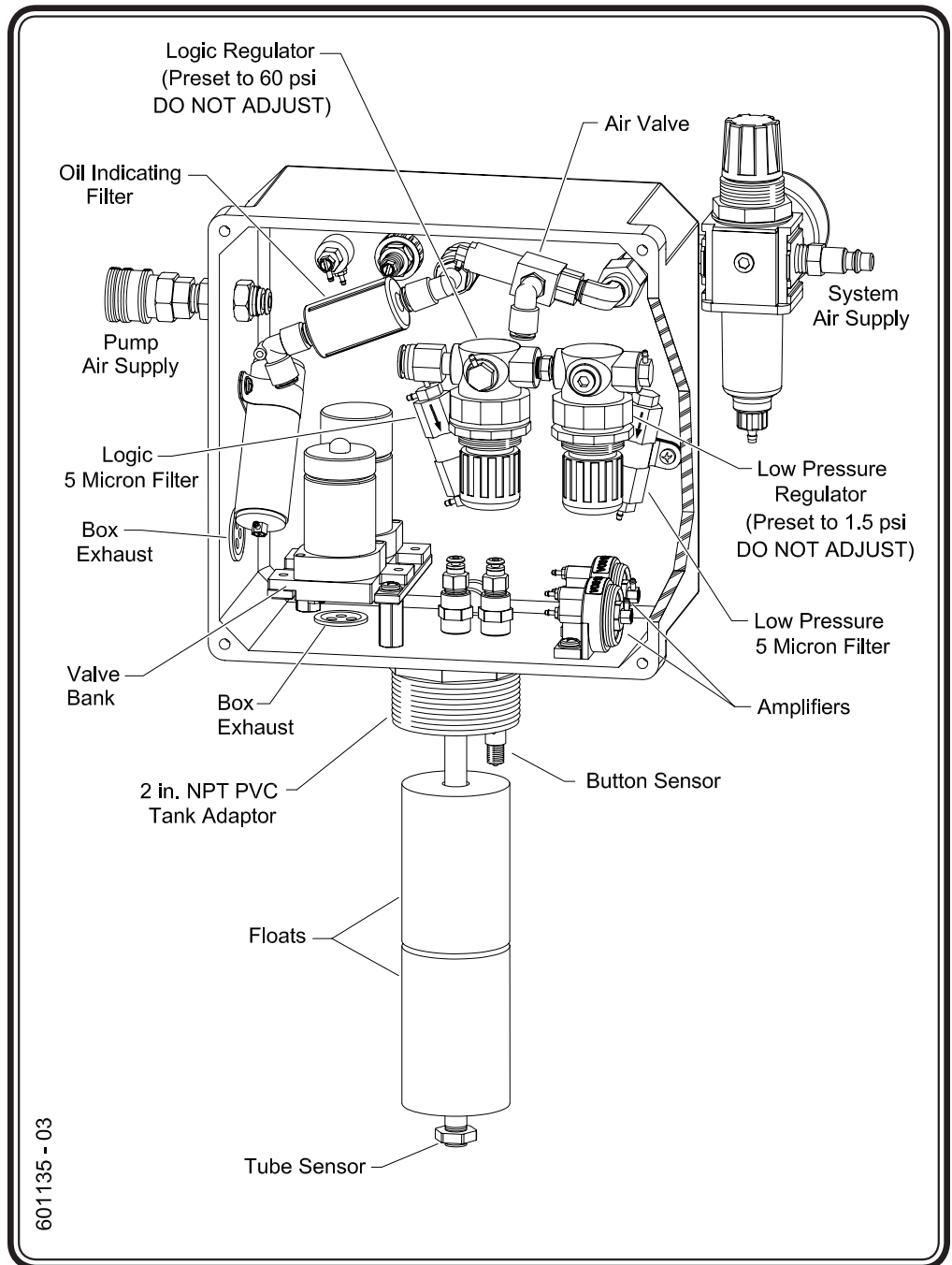
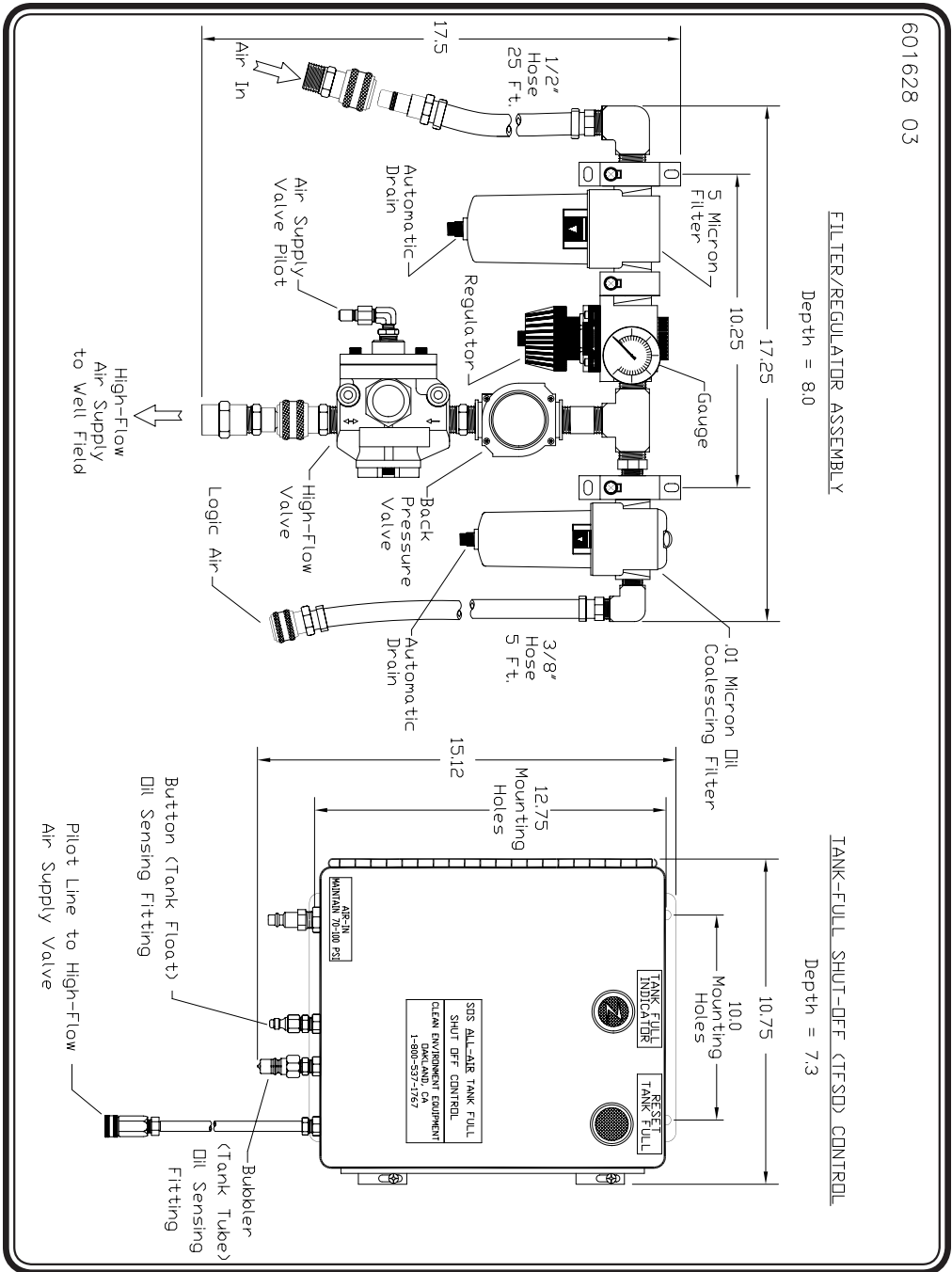

Figure 10 - Tank-Mount Control Box Interior



**Figure 11 - High Flow Wall-Mount Control Box and Filter/Regulator**

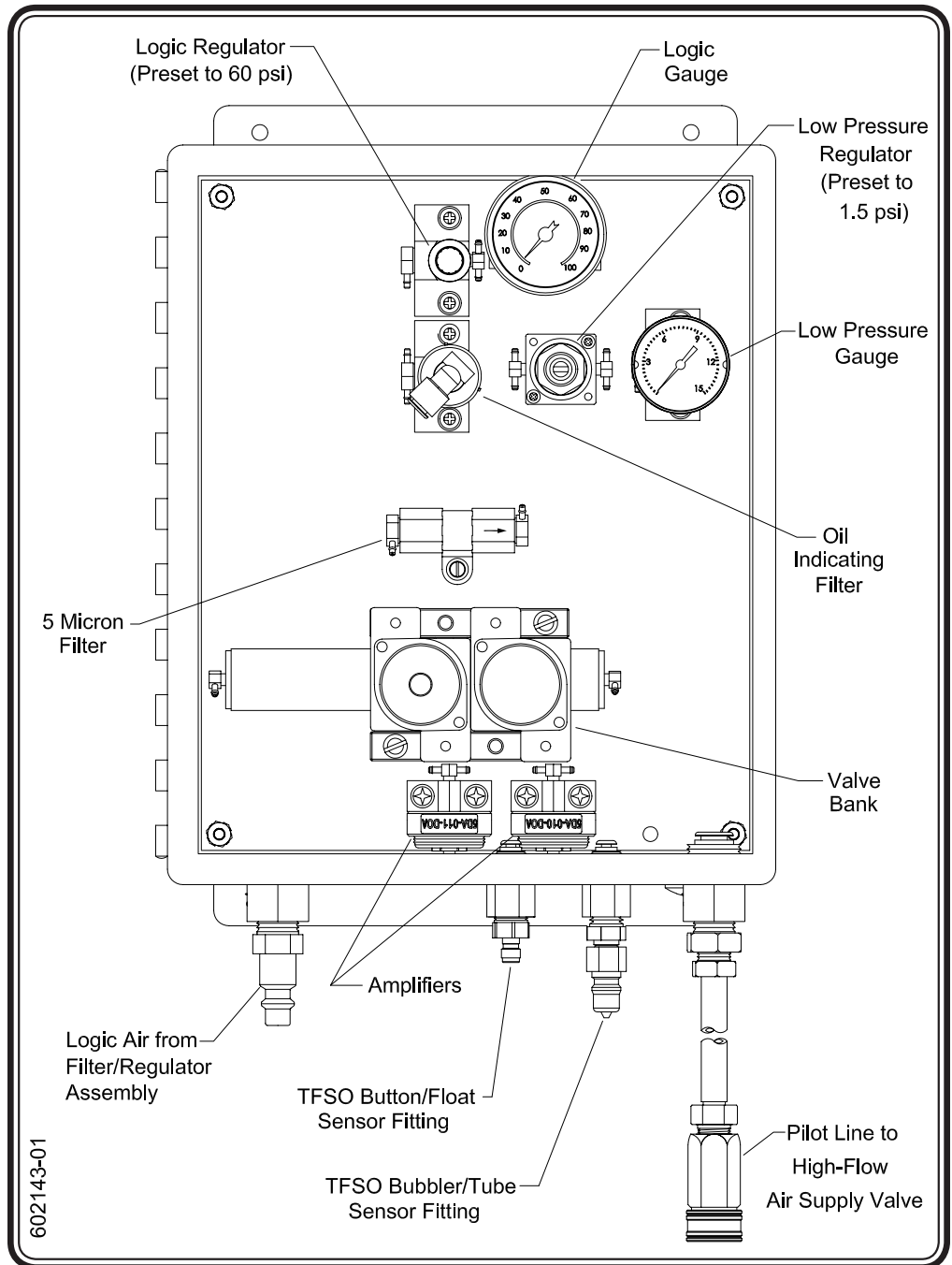

Figure 12 - High Flow Control Interior



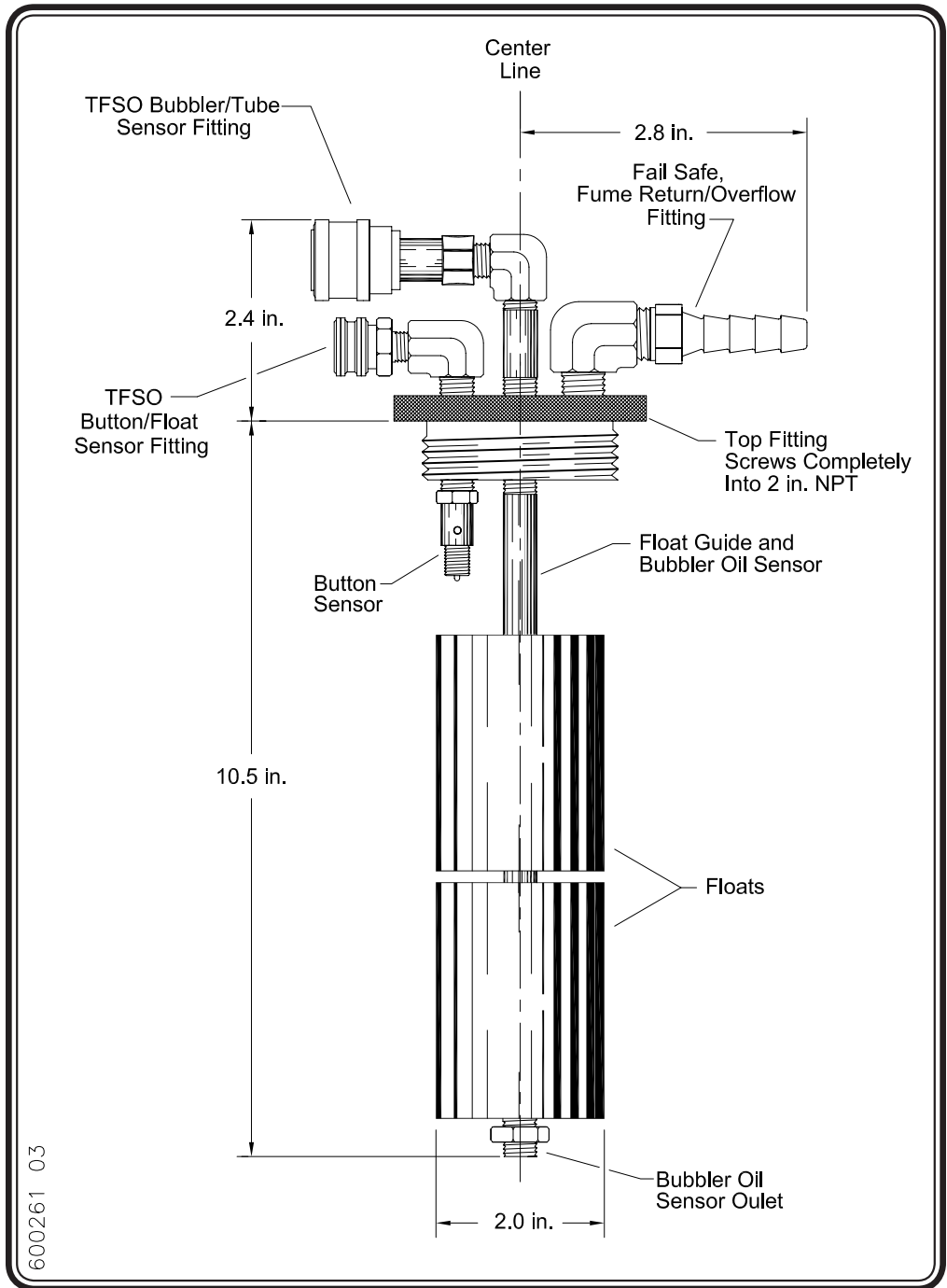

Figure 13 - Tank-Full Shut-Off (TFSO) Tank Unit (Wall-Mount Systems)

## Hoses and Fittings

Three types of hoses or tubes are supplied with the TFSO System. The table below shows the normal hose colors. These may change due to application or need.

**Hose/Tubing Color Code Table**

<b>Color/Material</b>	<b>Name</b>	<b>Function</b>	<b>Fittings</b>
<b>Hose:</b> Gray/Nitrile, PVC <b>Tubing:</b> Black/Nylon or White/ Polyethylene <b>Size:</b> 1/8-inch <b>(Wall-Mount Models Only.)</b>	Dual TFSO Sensor	Monitors the product in the recovery tank.	Quick-connects. One set has a valve in both ends while the other has no valve in either end.
<b>Hose:</b> Gray/Nitrile, PVC <b>Tubing:</b> Black/Nylon or White/ Polyethylene <b>Size:</b> 3/8-inch	Fume return/overflow	Returns overflow to well or auxiliary drum.	Hose bars.
<b>Hose:</b> Blue/Nitrile, PVC <b>Tubing:</b> Black/Nylon or White/ Polyethylene <b>Size:</b> 3/8-inch	System air supply	Supplies air pressure to the control box.	Hose bars or one-way quick-connects.

## Options and Accessories

### Tank Adapter

The tank adapter threads into the recovery tank to act as an intake and vent/overflow fitting. It has 3/4 inch NPT threads made of brass to reduce spark hazard. (See Figure 14)

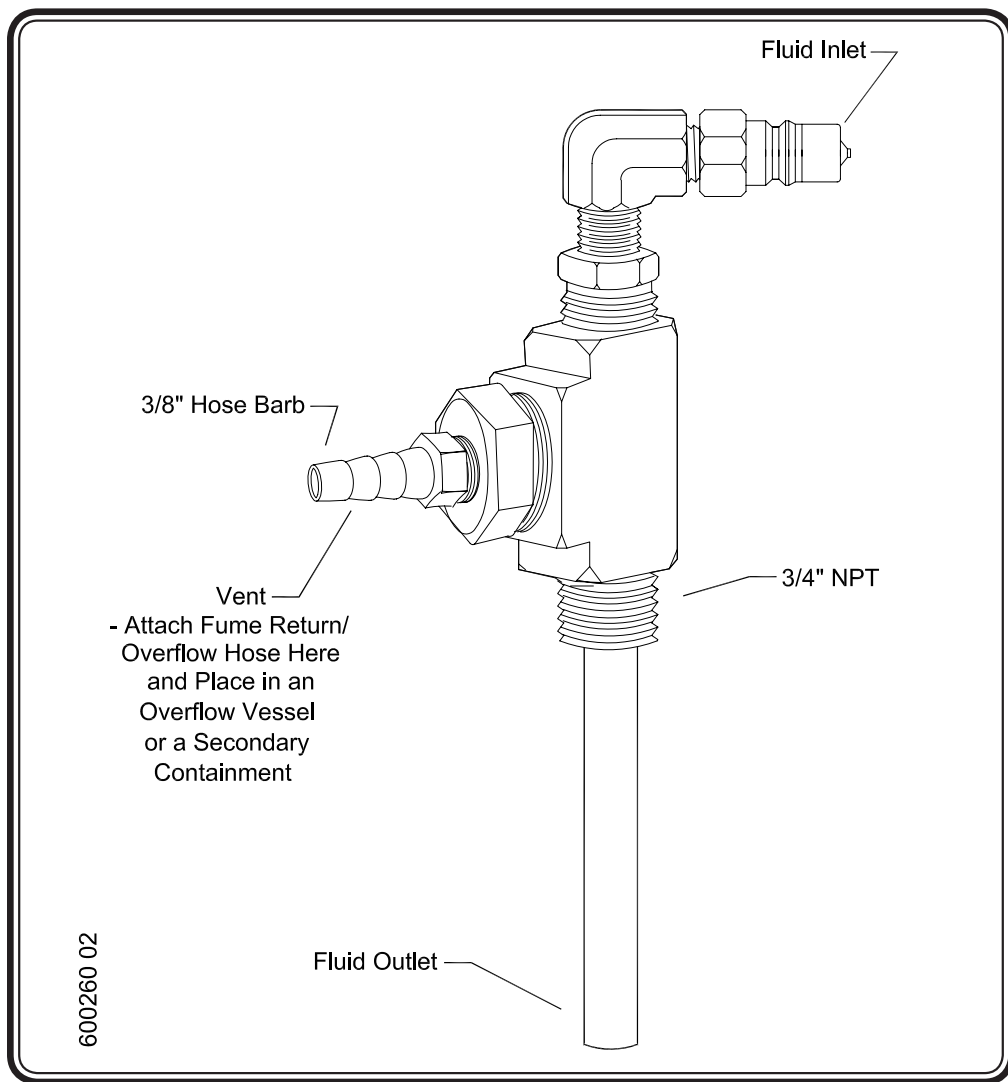

Figure 14 - Tank Adapter for Product Only Systems

## Downstream Equipment Air Supply Hose

Color/Material	Name	Function	Fittings
<b>Hose:</b> Red, Blue or Green/ Nitrile, PVC <b>Tubing:</b> Black/Nylon or White/ Polyethylene <b>Size:</b> 3/8-inch	Downstream Equipment Air Supply	Supplies air pressure to the downwell system.	Quick-connects are optional and vary depending upon equipment.

Please contact *QED* for more information on Options and Accessories.

## Terms, Conditions, and Warranty

### **ONE YEAR Warranty**

This limited warranty is in lieu of and excludes all other representations made by advertisements, distributors, agents, or manufacturers sales representatives, and all other warranties, both express and implied. There are no implied warranties of merchantability or of fitness for a particular purpose for goods covered hereunder.

QED Environmental Systems warrants to the purchaser of its products that, subject to the limitations and conditions provided within the Terms & Conditions of Sale, products, materials and/or workmanship shall reasonably conform to descriptions of the products and shall be free of defects in material and workmanship.

All warranty durations are calculated from the original date of purchase—determined as beginning the date of shipment from QED facilities and the date QED is notified of a warranty claim. This warranty shall be limited to the duration and conditions set forth below.

1. Pumps, hose, tubing, fittings, heater, condensers and air filtration housings — warranted for one (1) year: 100% material and 100% workmanship. There will be no warranty for application or material compatibility. The materials used vary depending upon application and the customer is responsible for knowing the environment in which the equipment will be operating and working with QED to determine what materials of construction will be best for the application.
2. Pneumatic Data Modules / Logic Control Panels — warranted for one (1) year: 100% material and 100% workmanship.
3. Parts and Repairs — warranted for ninety (90) days: 100% material and 100% workmanship; when repairs are performed by QED or its appointed agent; from date of repair or for the full term of the original warranty, whichever is longer. Separately sold parts are warranted for ninety (90) days: 100% materials and 100% workmanship.

This warranty will be void in the event of unauthorized disassembly of component assemblies. Defects in any equipment that result from abuse, operation in any manner outside the recommended procedures, use and applications other than for intended use or exposure to chemical or physical environments beyond the designated limits of materials and construction, will also void the warranty.

Chemical attack by liquids and/or abrasive substances contacting equipment and accessories shall not be covered by this warranty. A range of materials of construction is available from QED and it is the Buyer's responsibility to select materials of construction to fit the Buyer's application. QED will only warrant that the supplied site liquid contacting materials will conform to published QED specifications and generally accepted standards for that particular material.

QED Environmental Systems shall be released from all obligations under all warranties if any product covered hereby is repaired or modified by persons other than QED service personnel (unless such repair by others is made with the written consent of QED); resold to other parties; and/or moved to or used on a remediation site other than originally specified.

It is understood and agreed that QED Environmental Systems shall in no event be liable for incidental or consequential damages resulting from its breach of any of the terms of this agreement, nor for special damages, nor for improper selection of any product described or referred to for a particular application. Liability under this warranty is limited to repair or replacement F.O.B. QED's factory, or its appointed agent's shop, of any parts which prove to be defective within the duration and conditions set forth herein, or repayment of the purchase price at the option of QED, provided the products have been returned in accordance with the duration and conditions set forth herein.

### **Subassemblies and Other Equipment Manufactured by Others**

The foregoing warranty does not apply to major subassemblies and other equipment, accessories, and other parts manufactured by others, and such other parts, accessories, and equipment are subject only to the warranties, if any, supplied by their respective manufacturers. QED makes no warranty concerning products or accessories not manufactured by QED. In the event of failure of any such product or accessory, QED will give reasonable assistance to Buyer in obtaining from the respective manufacturer whatever adjustment is reasonable in light of the manufacturer's own warranty.

**Illustrations and Drawings**

Reasonable Effort has been made to have all illustrations and drawings accurately represent the product(s) as it actually was at the time of doing the illustrations and drawings.

However, products may change to meet user requirements and therefore may not be reflected in the literature. In addition, literature may be updated to reflect the most recent equipment revision(s). Changes to either or both equipment and/or literature can be made without notice.

**Buyer's Remedies**

The buyer's exclusive and sole remedy on account of or in respect to the furnishing of defective material or workmanship shall be to secure replacement thereof as aforesaid. QED shall not in any event be liable for the cost of any labor expended on any such product or material or for any special, direct, indirect or consequential damages to any one by reason of the fact that it shall have been deemed defective or a breach of said warranty.

**Changes without Notice**

Prices and Specifications are subject to change without notice.

**Shipping Dates**

Shipping dates are approximate and are subject to delays beyond our control.

**F.O.B. Point and Title**

All material is sold F.O.B. factory. Title to all merchandise sold shall pass to Buyer upon delivery by Seller to carrier at factory. All freight insurance is the responsibility of the Buyer and shall be charged to the Buyer on the invoice unless directed in writing. All Freight claims are the Buyer's responsibility.

**Terms**

Payment terms are net 30 days; 1.5% per month past due.

**State and Local Taxes**

Any taxes, duties or fees which the seller may be required to pay or collect upon or with respect to the sale, purchase, delivery, use or consumption of any of the material covered hereby shall be for the account of the Buyer and shall be added to the purchase price.

**Acceptance**

All orders shall be subject to the terms and conditions contained or referred to in the Seller's quotation, acknowledgments, and to those listed here and to no others whatsoever. No waiver, alteration or modification of these terms and conditions shall be binding unless in writing and signed by an executive officer of the Seller. All orders subject to written acceptance by QED Environmental Systems, Oakland, CA, U.S.A.

**Warranty Claims Procedure (Responsibility of purchaser)**

The original purchaser's sole responsibility in the instance of a warranty claim shall be to notify QED or its appointed agent, of the defect, malfunction, or other manner in which the terms of this warranty are believed to be violated. The purchaser may secure performance of obligations hereunder by contacting the Customer Service Department of QED or its appointed agent, and:

1. Identifying the product involved by model or serial number, or other sufficient description, that will allow QED, or its appointed agent, to determine which product is defective.
2. Specifying where, when, and from whom the product was purchased.
3. Describing the nature of the defect or malfunction covered by this warranty.
4. After obtaining authorization from QED, sending the malfunctioning component via a RMA# (Return Material Authorization number) to the address below or to its appointed agent:

QED ENVIRONMENTAL SYSTEMS  
1565 Alvarado Street  
San Leandro, California 94577-2640  
USA

(800) 537-1767  
(510) 346-0400  
(510) 346-0414

Toll-Free in North America  
Tele.  
FAX

5. Equipment must be cleaned before shipment or it will be cleaned by QED before any work is performed. The customer will be charged for such cleaning.



If any product covered hereby is actually defective within the terms of this warranty, purchaser must contact QED, or its appointed agent, for determination of warranty coverage. If the return of a component is determined to be necessary, QED, or its appointed agent, will authorize the return of the component at Purchasers expense. If the product proves not to be defective within the terms of this warranty, then all costs and expenses in connection with the processing of the Purchaser's claim and all costs for repair, parts, labor, and shipping and handling, as authorized by owner hereunder, shall be borne by the Purchaser. In no event shall such allegedly defective products be returned to QED, or its appointed agent, without its consent, and QED's, or its appointed agent's, obligations of repair, replacement or refund are conditional upon the buyer's return of the defective product to QED, or its appointed agent. All equipment returned to QED will be appropriately cleaned of contamination before shipping.





